

Technisches Datenblatt / Technical Datasheet

Art.-No. 20807

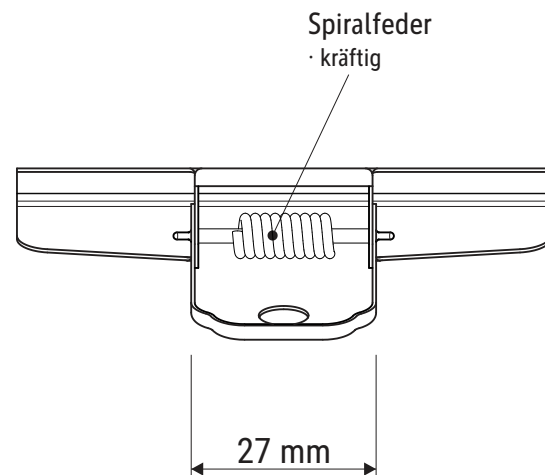

Klemmweite: max. 25 mm

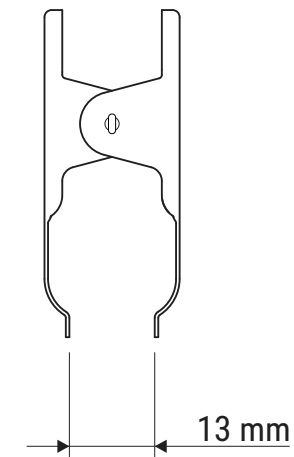
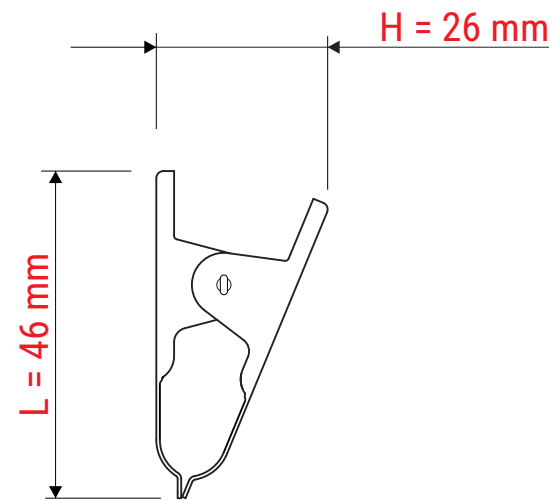
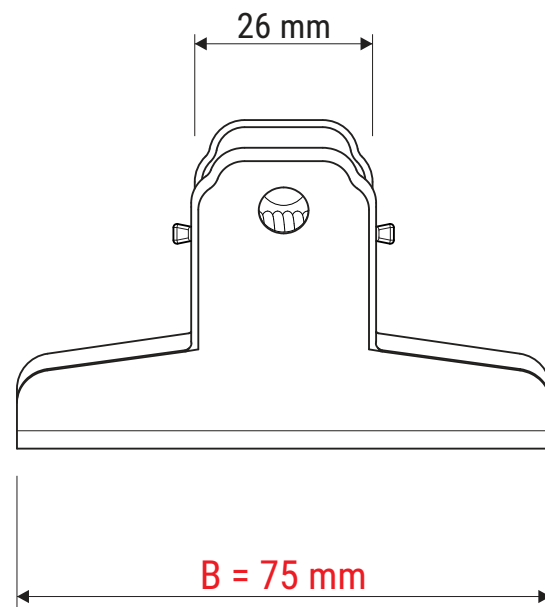
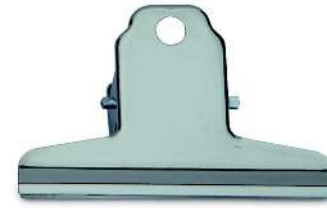
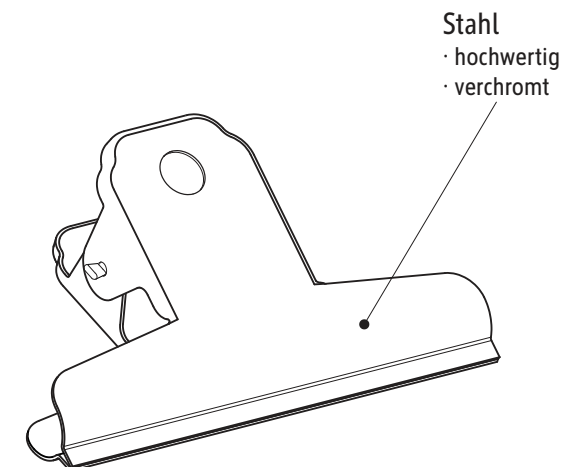

Abmaße Produkt: **L x B x H**
46 x 75 x 26 mm
Gewicht kompl.: 0,019 kg

Verp. Abmaße: L x B x H (10 Stck. im Karton)
113 x 110 x 43 mm
Gewicht kompl.: 0,215 kg