

MAULintro 820 59

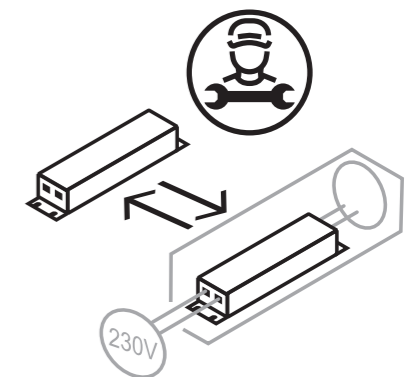

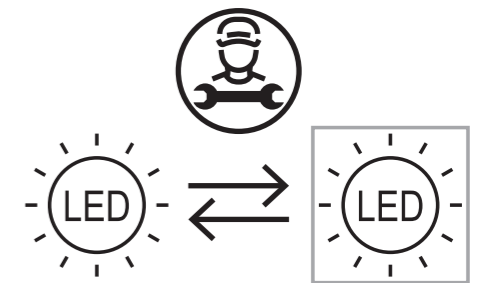
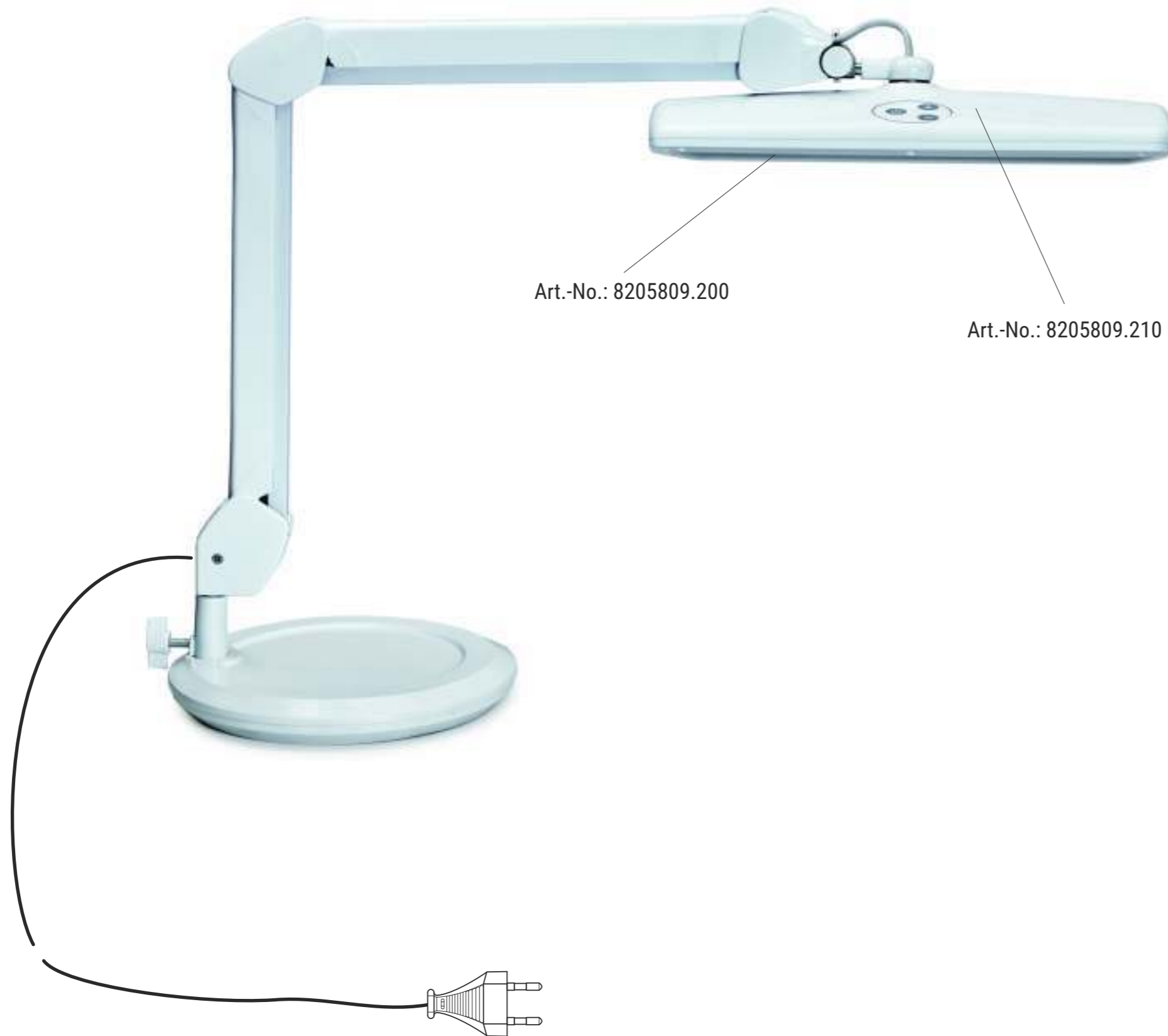
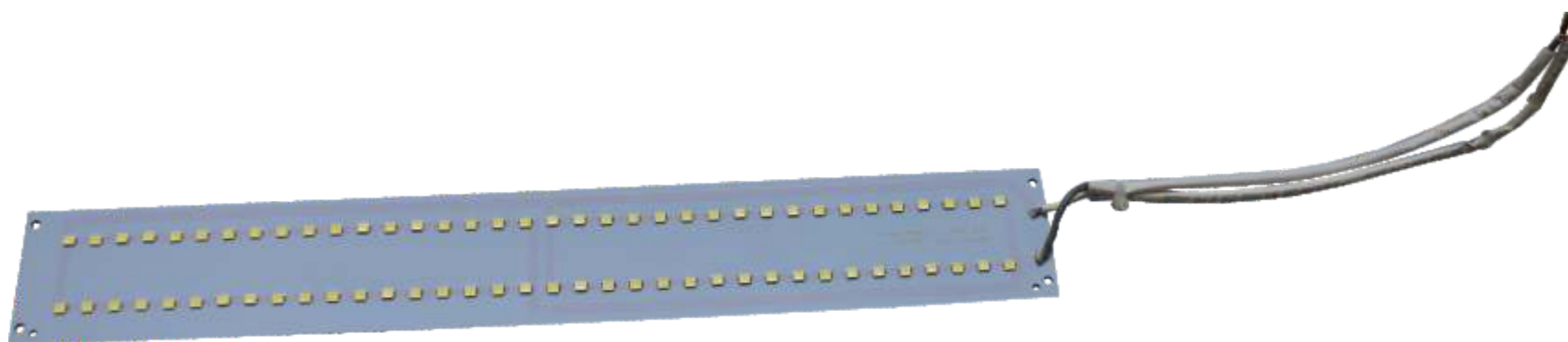
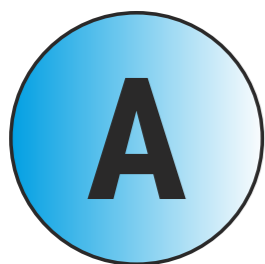

Art.-No.: 8205809.200

1



2

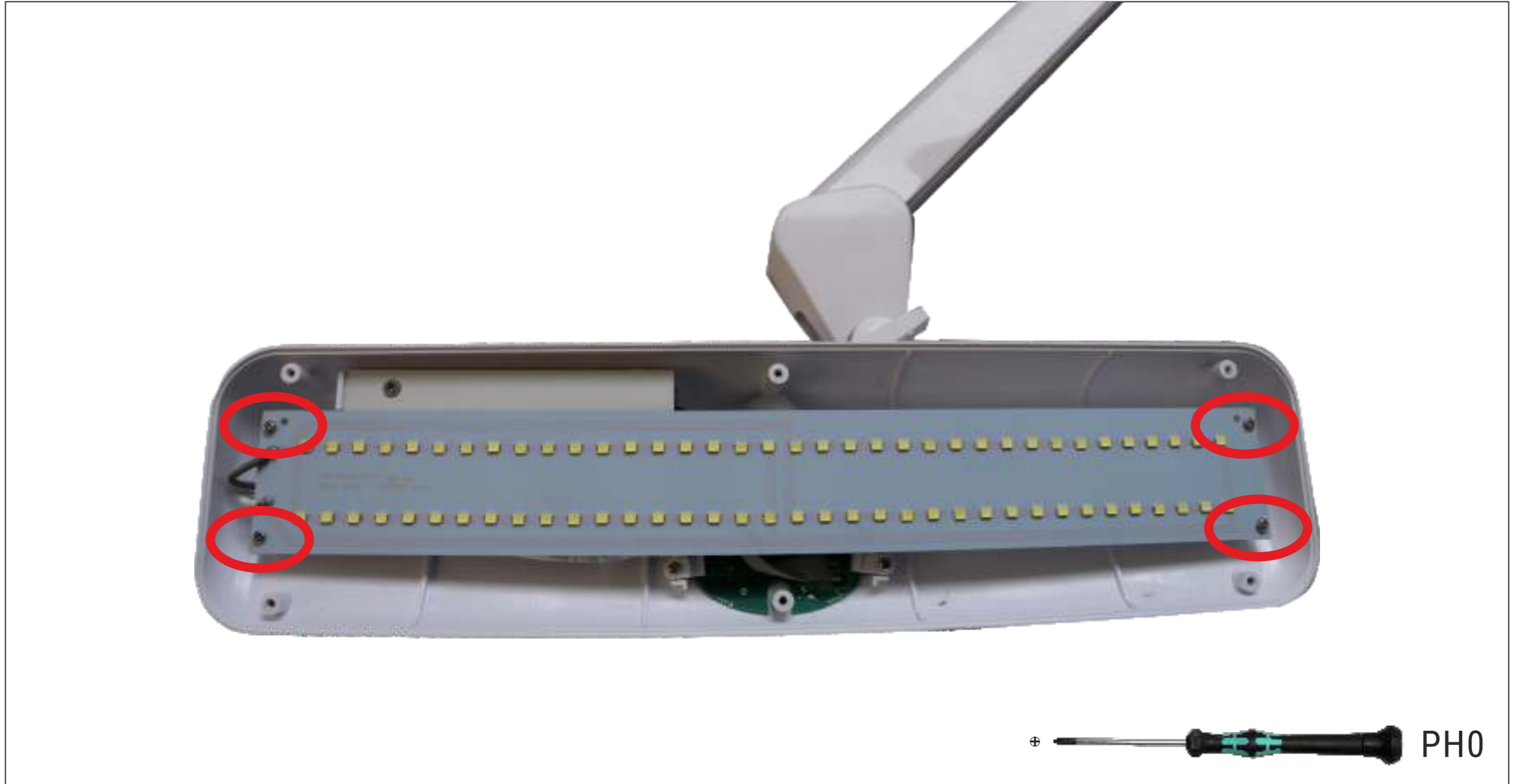

3

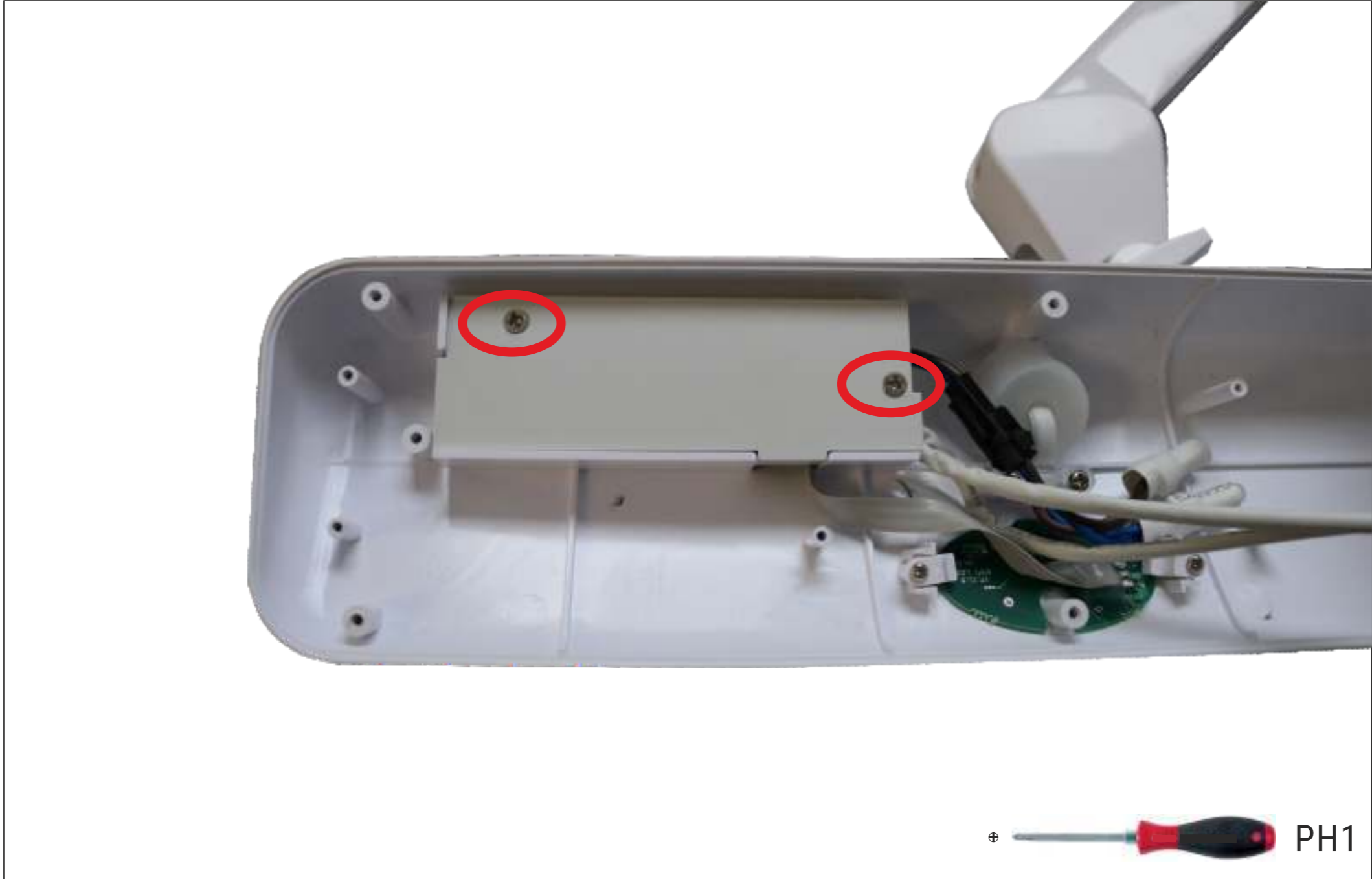

4

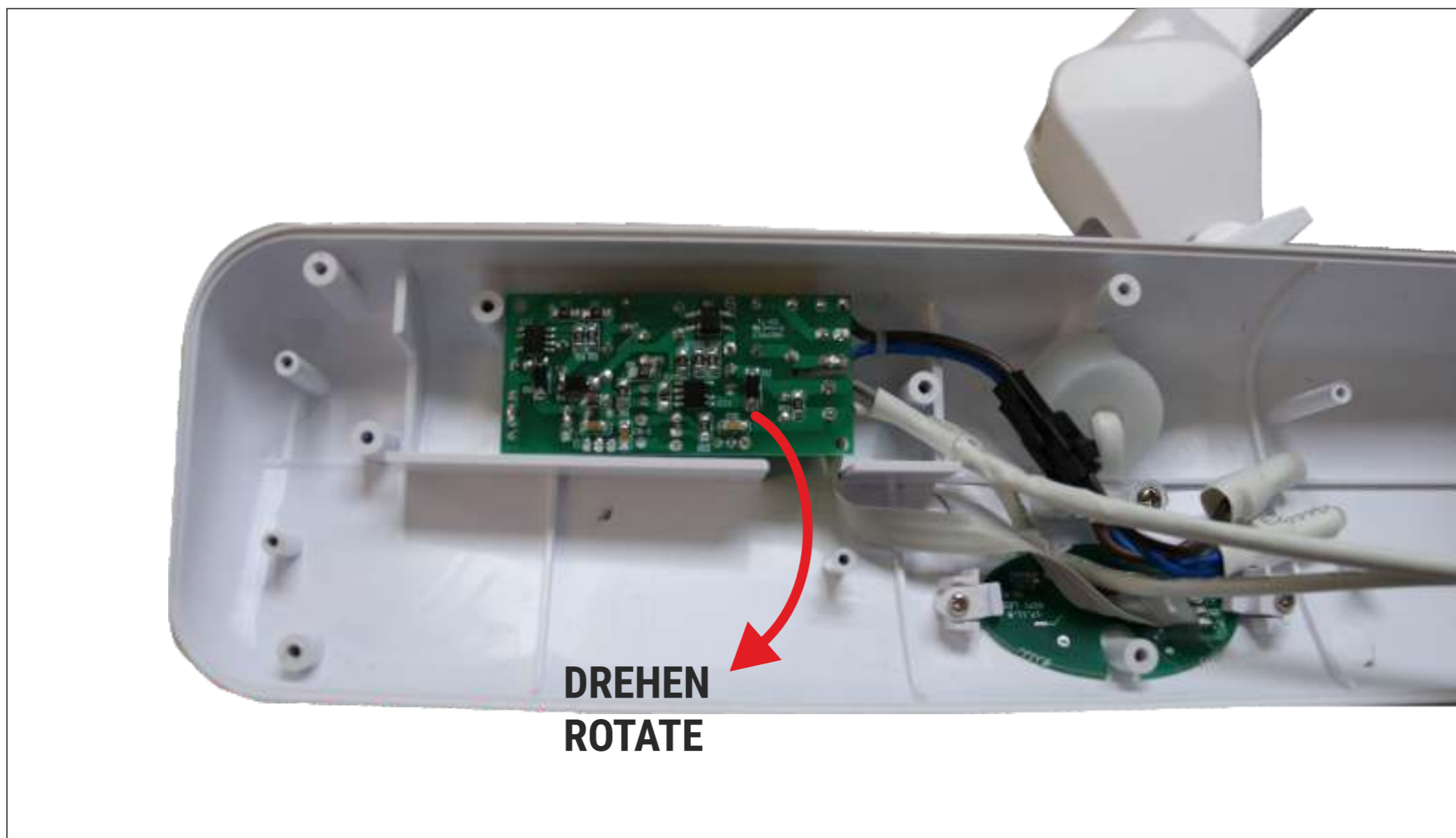

5

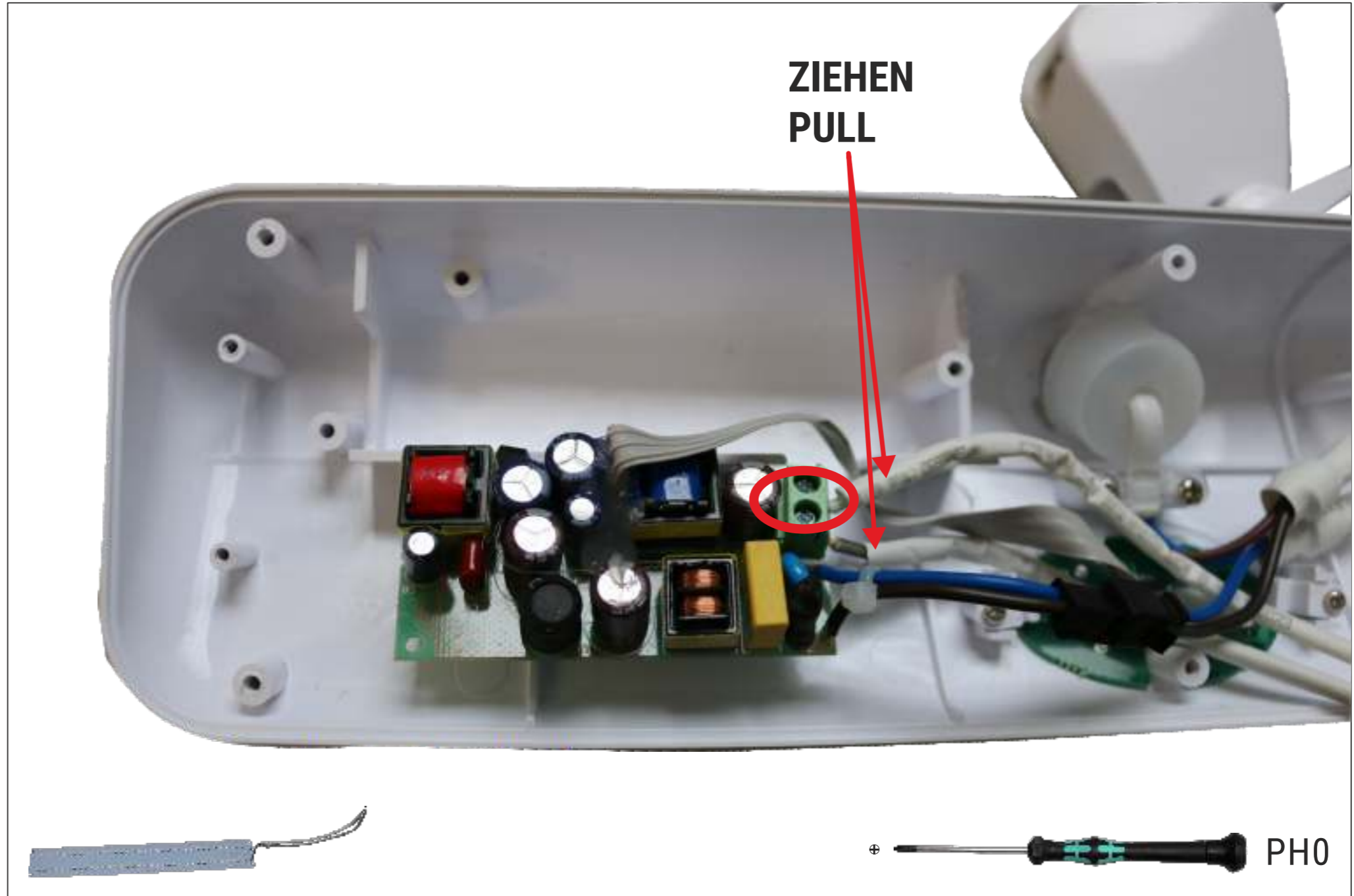

B

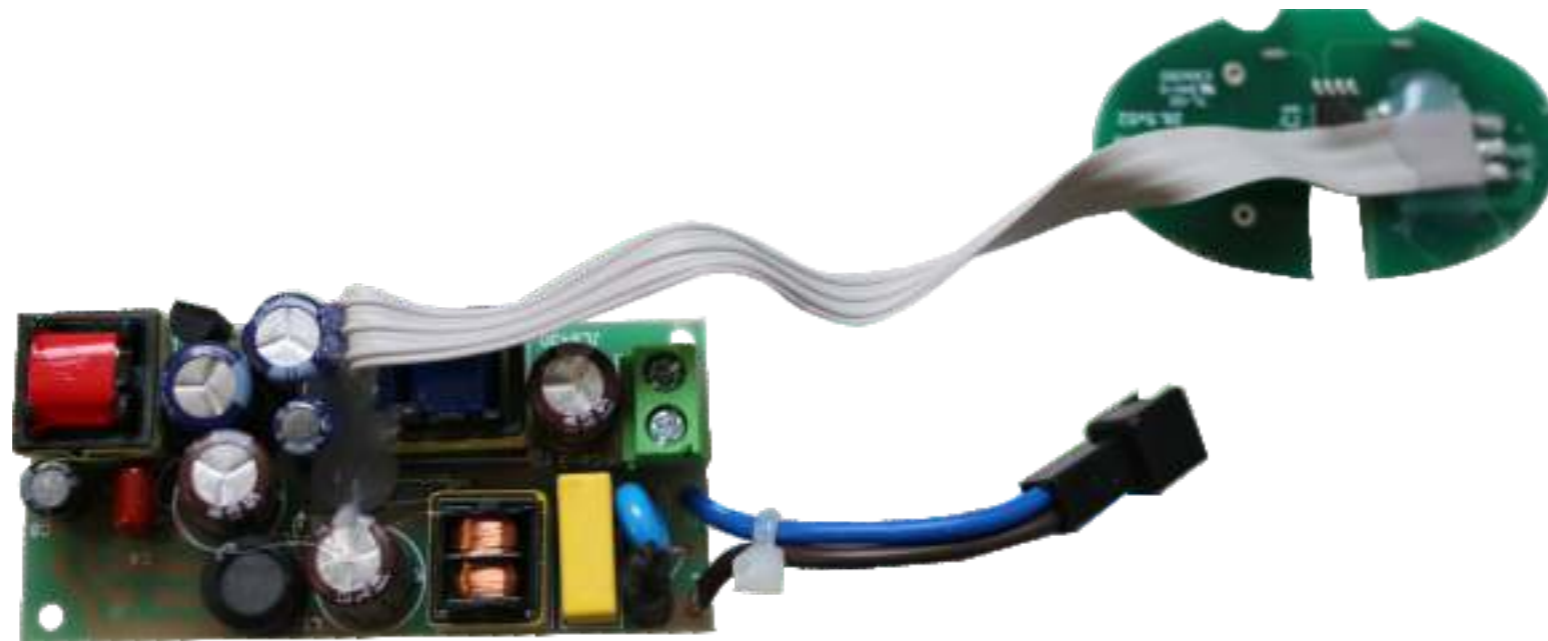

Art.-No.: 8205809.210

1

