

Technisches Datenblatt / Technical Datasheet

Art.-No. 51008



· für 8 Stempel

Metall
 · pulverbeschichtet
 · kratzfest
 · unempfindlich

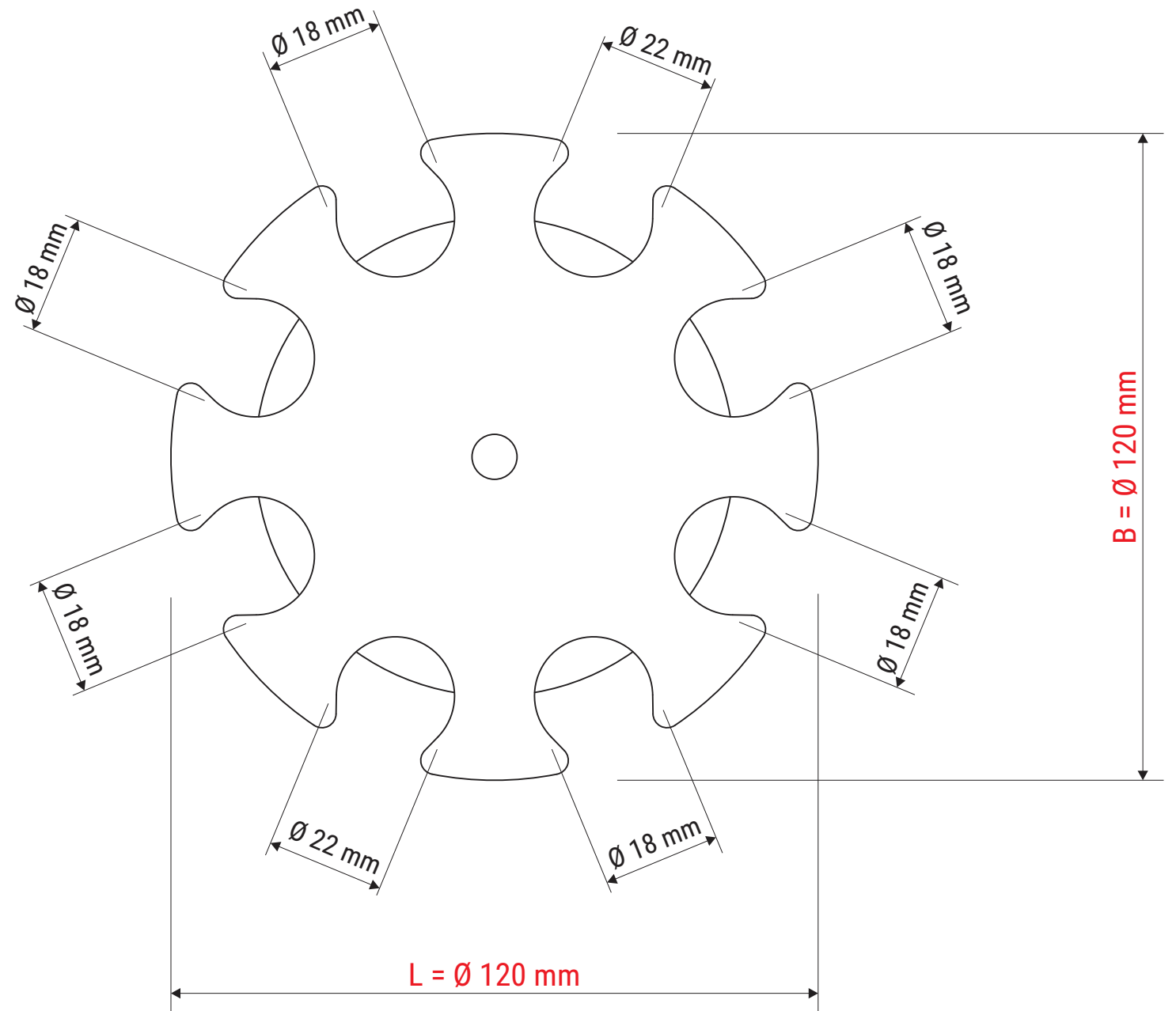
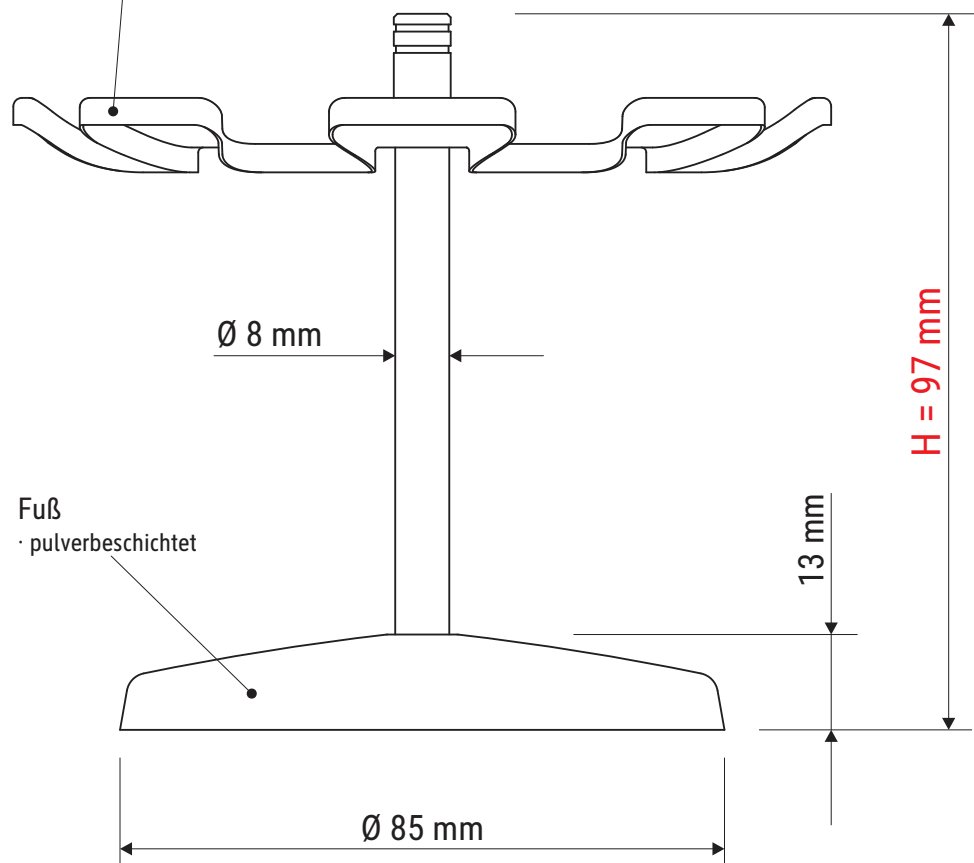

Abmaße Produkt: **L x B x H**
 120 x 120 x 97 mm
 Gewicht: 0,172 kg

Verp. Abmaße : L x B x H (1 Stck. im Karton)
 143 x 123 x 23 mm
 Gewicht kompl.: 0,198 kg