

# Technisches Datenblatt / Technical Datasheet

## Art.-No. 21105



Art.-Nr.: 2110590



Art.-Nr.: 2110596

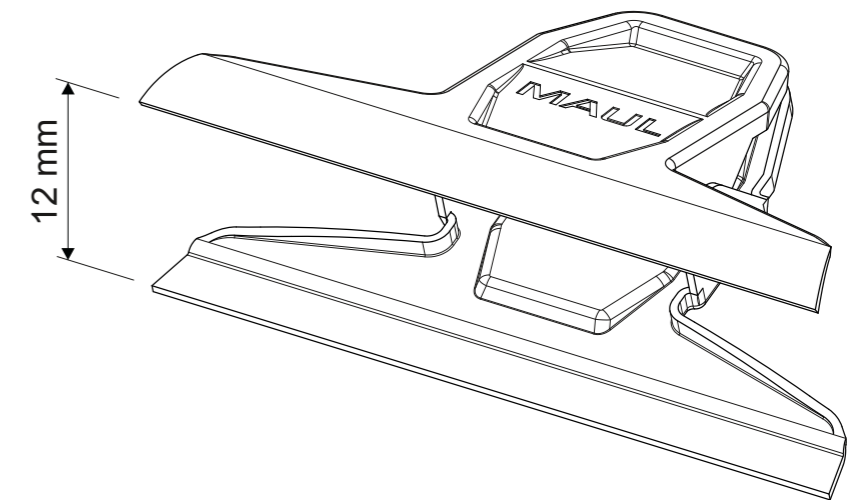
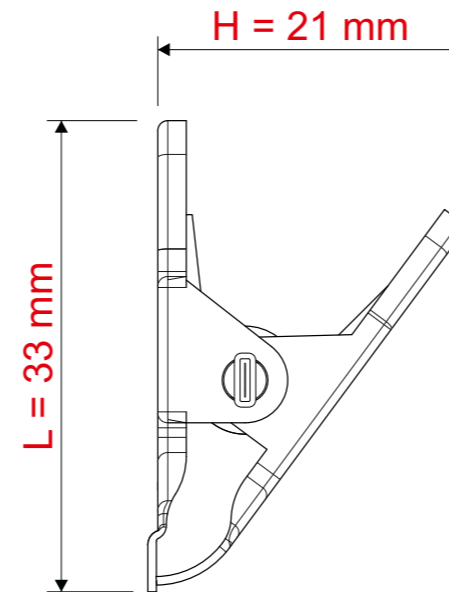
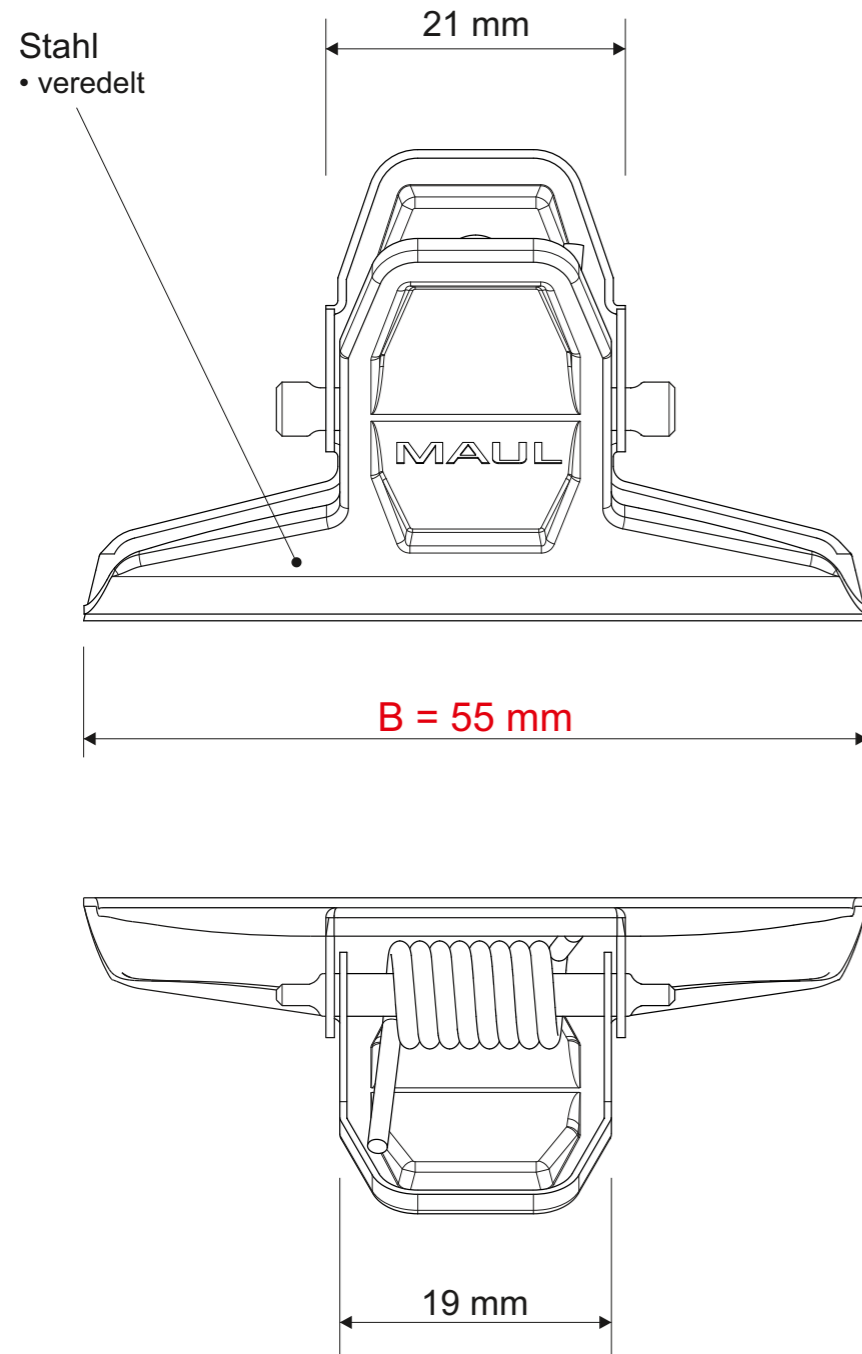

Klemmweite 12 mm

Abmaße Produkt: **L x B x H**  
33 x 55 x 21 mm  
Gewicht kompl.: 0,012 kg

Verp. Abmaße: L x B x H (2 Stck. im Folienbeutel mit Kopfkarte)  
100 x 100 x 21 mm  
Gewicht kompl.: 0,0285 kg