

Technisches Datenblatt / Technical Datasheet

Art.-No. 21840

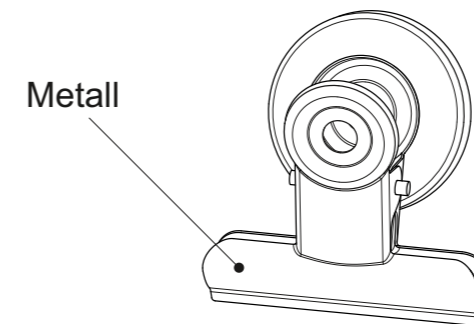
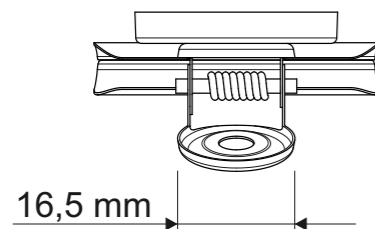
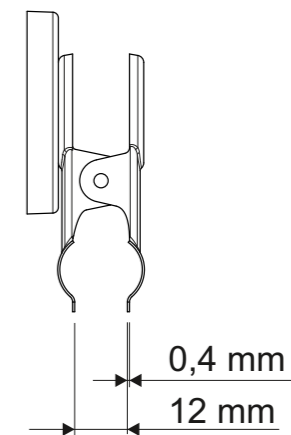
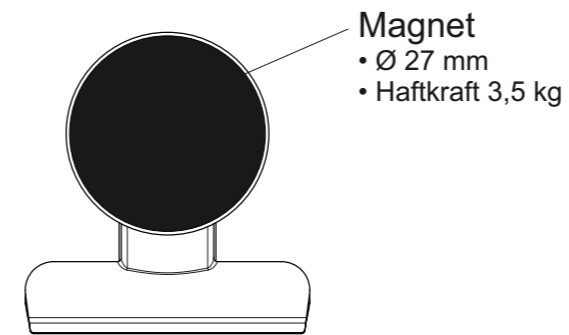
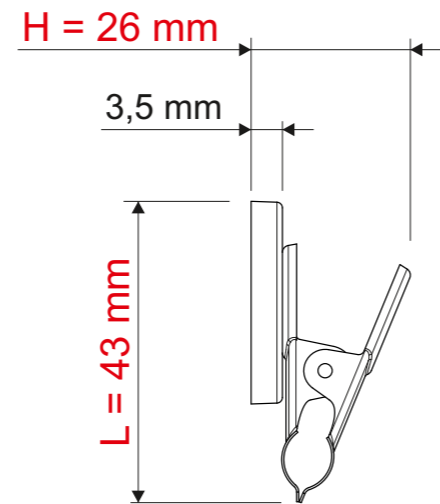
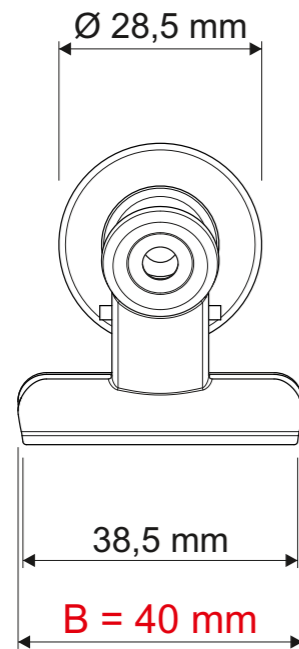

Klemmweite 12 mm

Abmaße Produkt: **L x B x H**
43 x 40 x 26 mm
Gewicht kompl.: 0,017 kg

Verp. Abmaße: L x B x H (2 Stck. in der Blisterverpackung)
160 x 75 x 29 mm
Gewicht kompl.: 0,043 kg