

Technisches Datenblatt / Technical Datasheet

Art.-No. 970 10



Art.-Nr.:
9701002

Art.-Nr.:
9701089

Art.-Nr.:
9701095

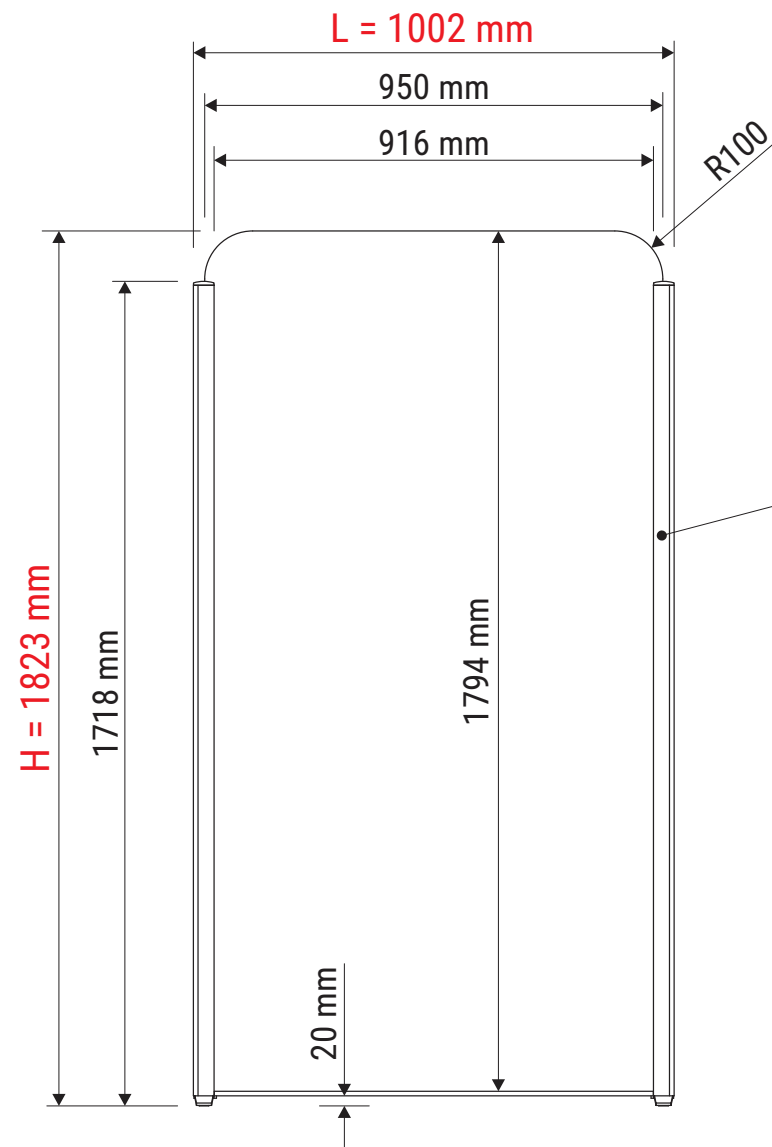

Rahmen:
· Aluminium
· in drei Farben:
weiß, anthrazit und silber

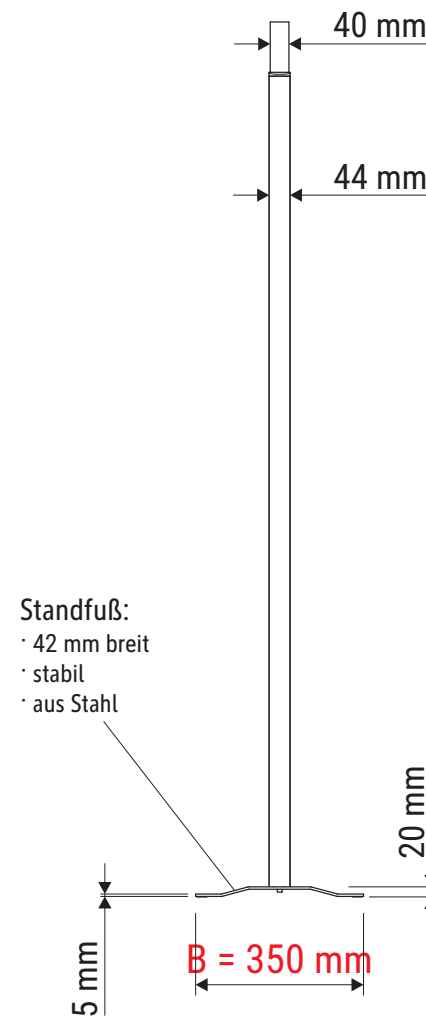

Standfuß:
· 42 mm breit
· stabil
· aus Stahl

Akustikvlies:
· massiv
· 4000 g/m²
· hohe Formstabilität
· aus 100% Polyester-Fasern
· dunkelgrau meliert

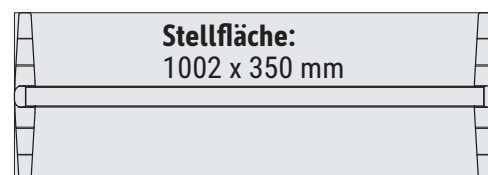

Abmaße Produkt: **L x B x H**
1002 x 350 x 1823 mm
Gewicht kompl.: 10,303 kg

Verp. Abmaße: L x B x H
2150 x 1260 x 90 mm
Gewicht kompl.: 17,296 kg

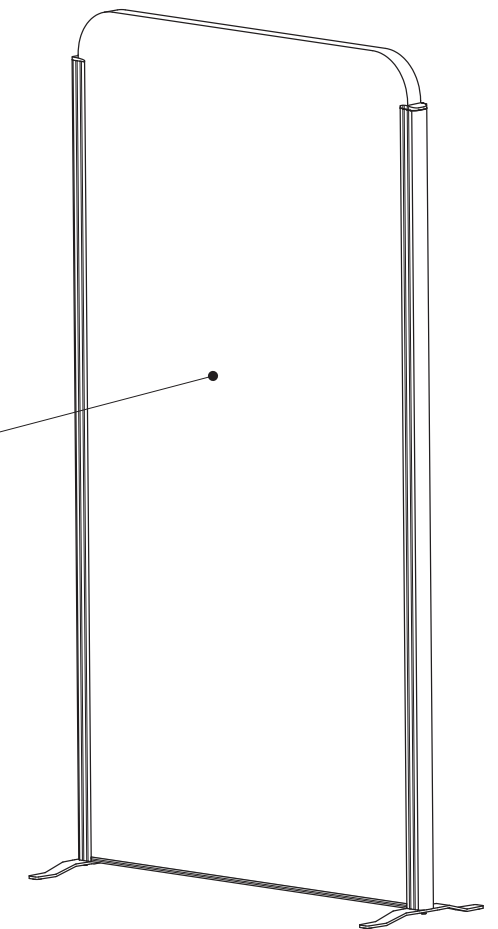

Technisches Datenblatt / Technical Datasheet

Art.-No. 970 10



· Lückenlose Klettverbindung



Art.-Nr.:
9701002



Art.-Nr.:
9701089



Art.-Nr.:
9701095

97010:

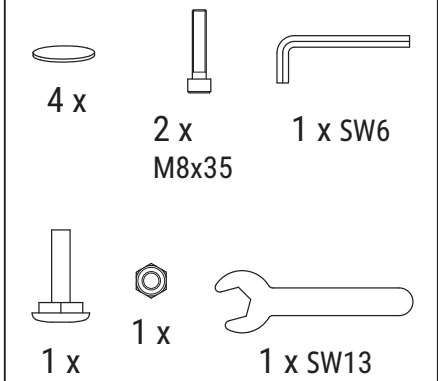

als Ersatzteil lieferbar:
Abpackbeutel
Art.-Nr.: 9600509.020

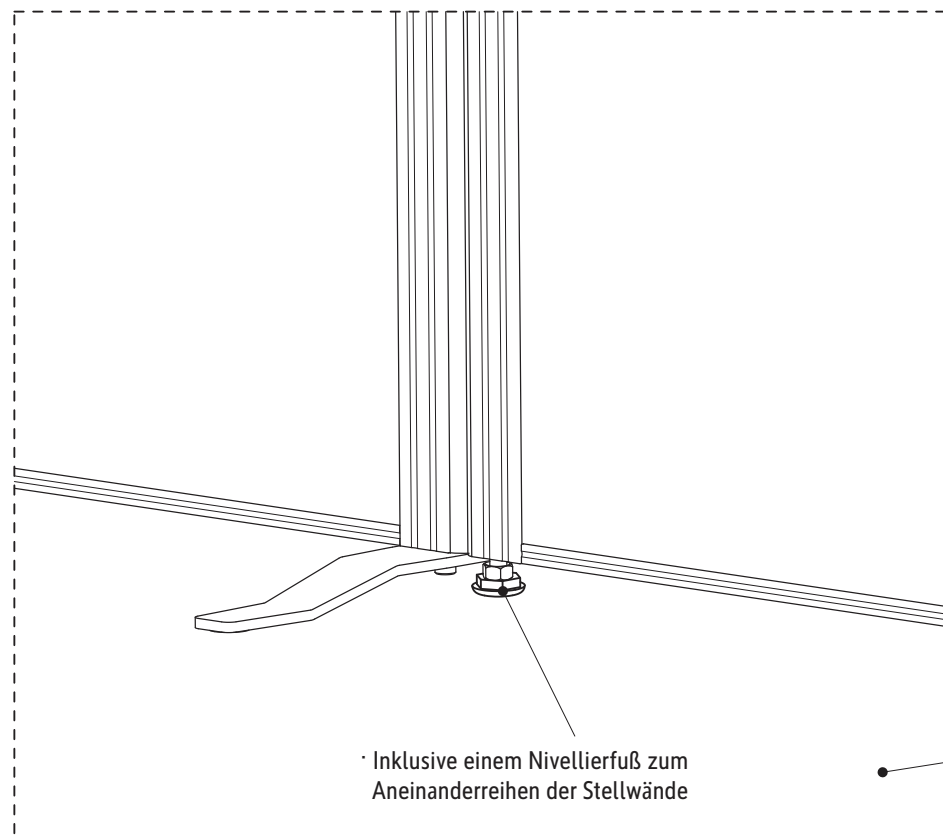

· Inklusive einem Nivellierfuß zum Aneinanderreihen der Stellwände

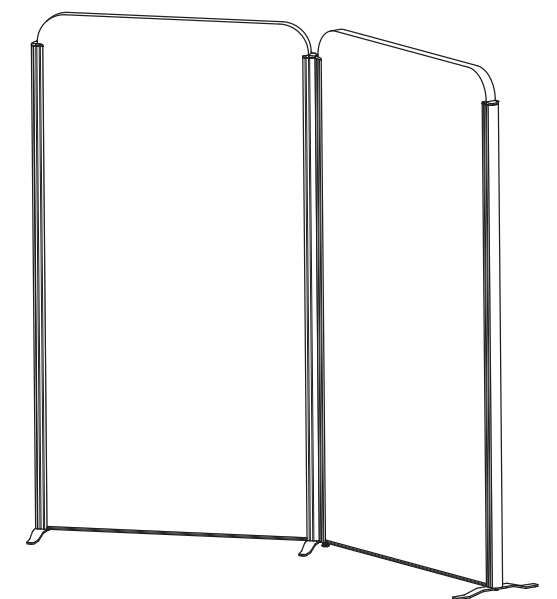
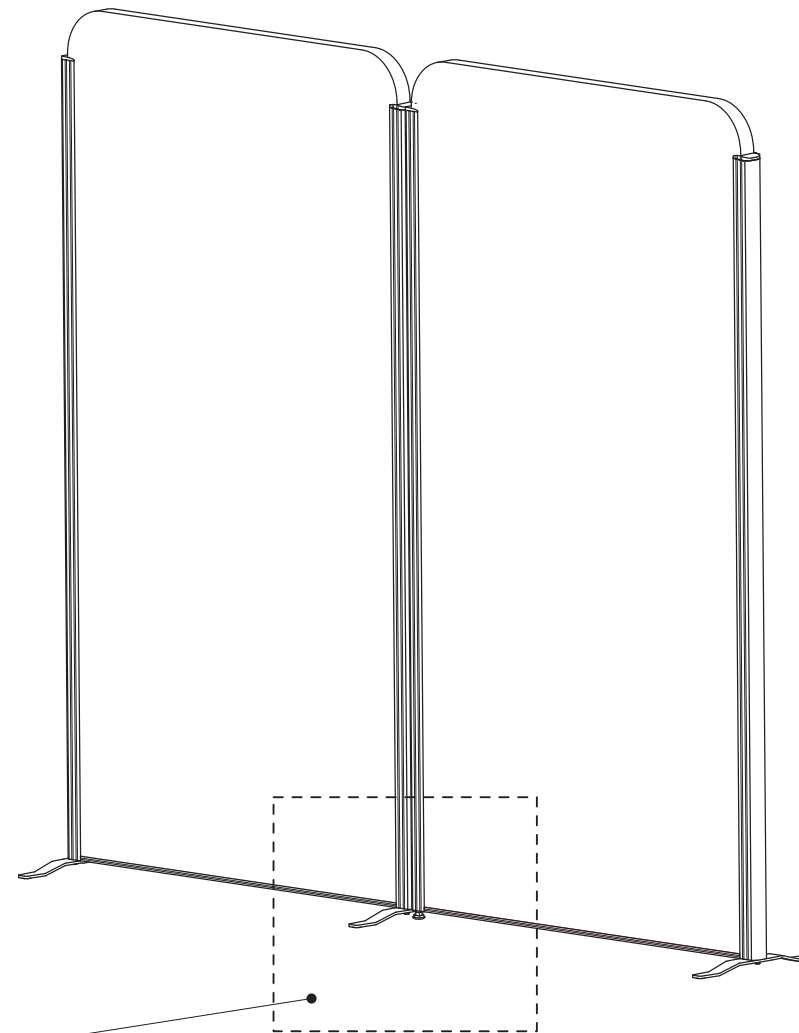

90° - 180° - 90°