

# Technisches Datenblatt / Technical Datasheet

## Art.-No. 970 10

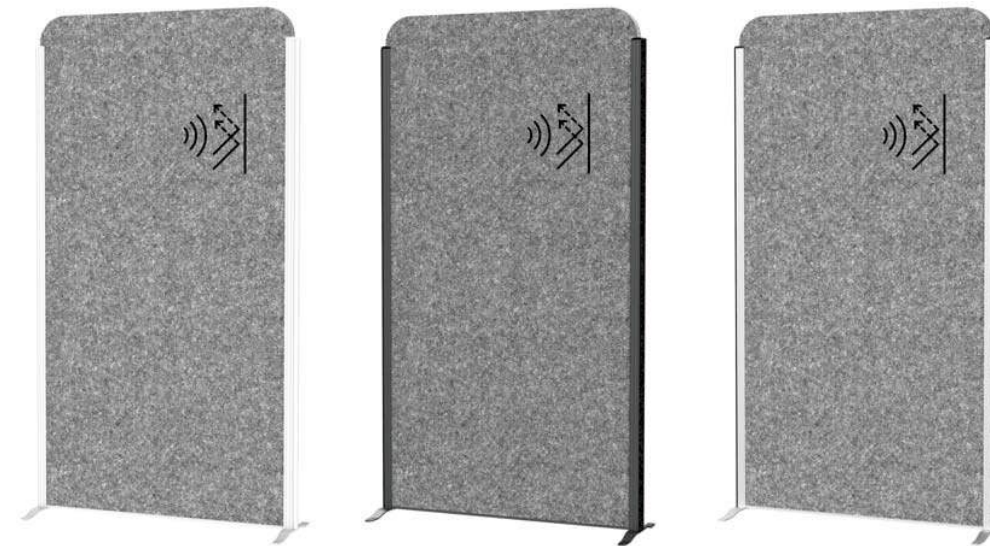

Art.-Nr.:  
9701002

Art.-Nr.:  
9701089

Art.-Nr.:  
9701095

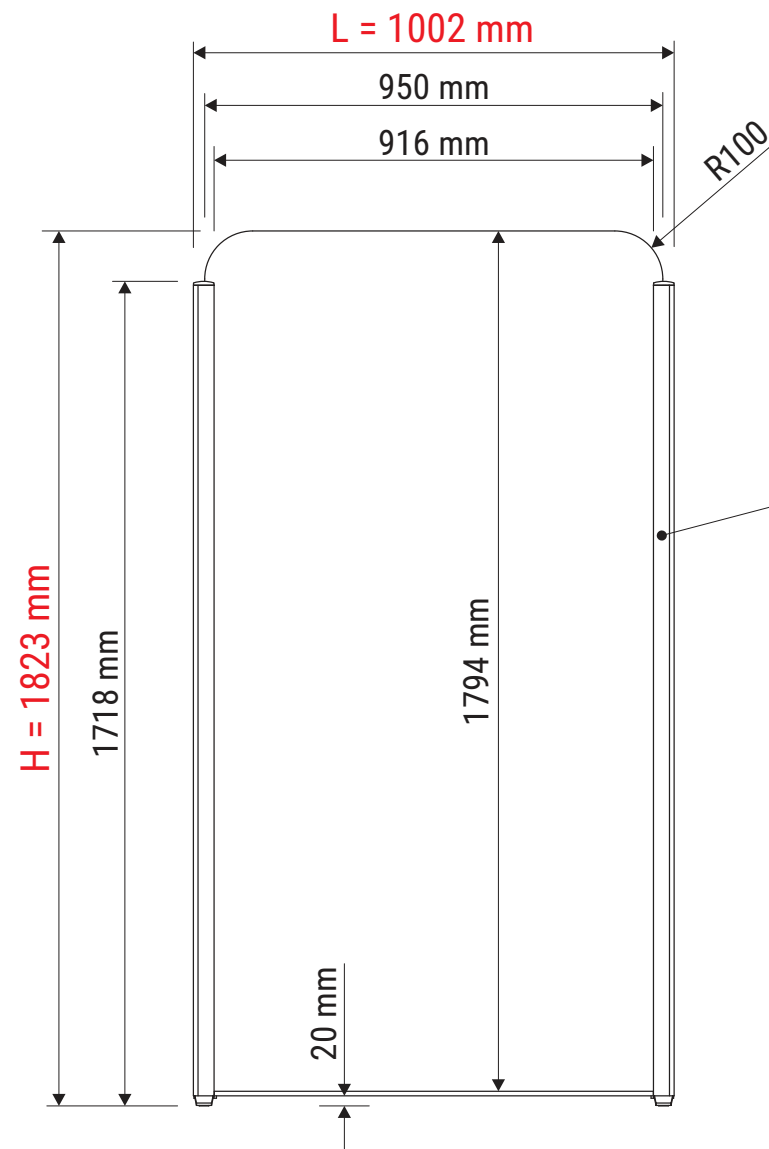

Rahmen:  
· Aluminium  
· in drei Farben:  
· weiß, anthrazit und silber

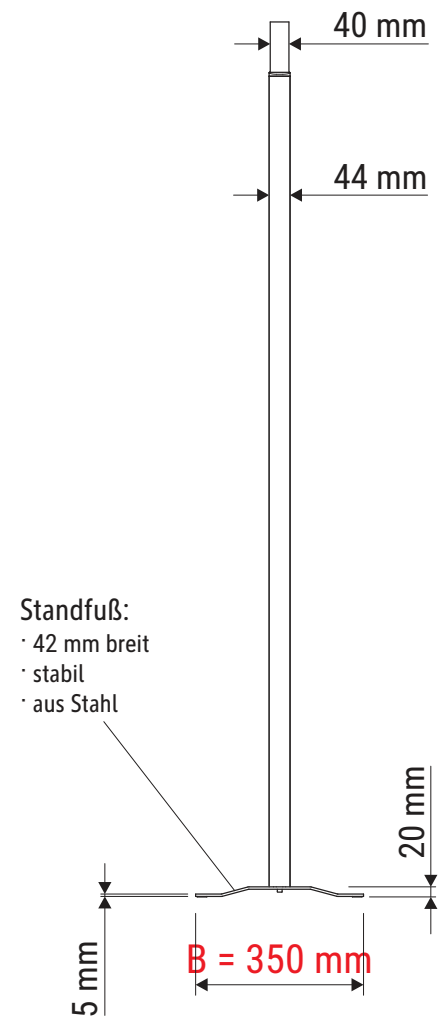

Standfuß:  
· 42 mm breit  
· stabil  
· aus Stahl

Akustikvlies:  
· massiv  
· 4000 g/m<sup>2</sup>  
· hohe Formstabilität  
· aus 100% Polyester-Fasern  
· dunkelgrau meliert

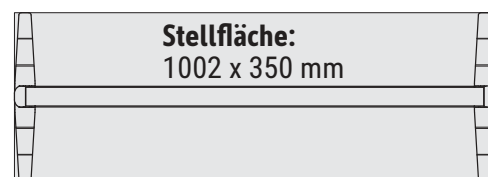
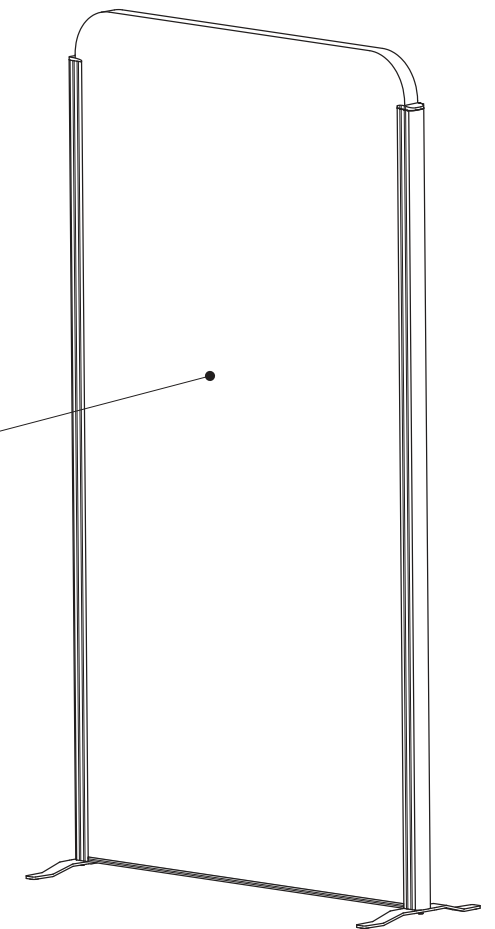

Abmaße Produkt: **L x B x H**  
1002 x 350 x 1823 mm  
Gewicht kompl.: 10,303 kg

Verp. Abmaße: L x B x H  
2150 x 1260 x 90 mm  
Gewicht kompl.: 17,296 kg

# Technisches Datenblatt / Technical Datasheet

## Art.-No. 970 10



· Lückenlose Klettverbindung



Art.-Nr.:  
9701002



Art.-Nr.:  
9701089



Art.-Nr.:  
9701095

### 97010:

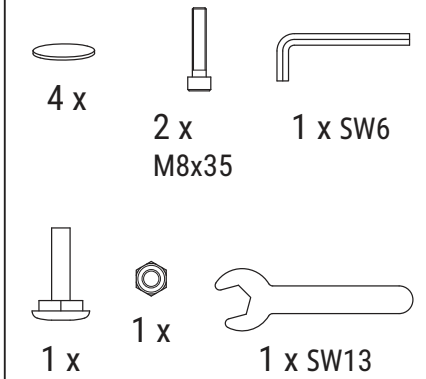

als Ersatzteil lieferbar:  
Abpackbeutel  
Art.-Nr.: 9600509.020

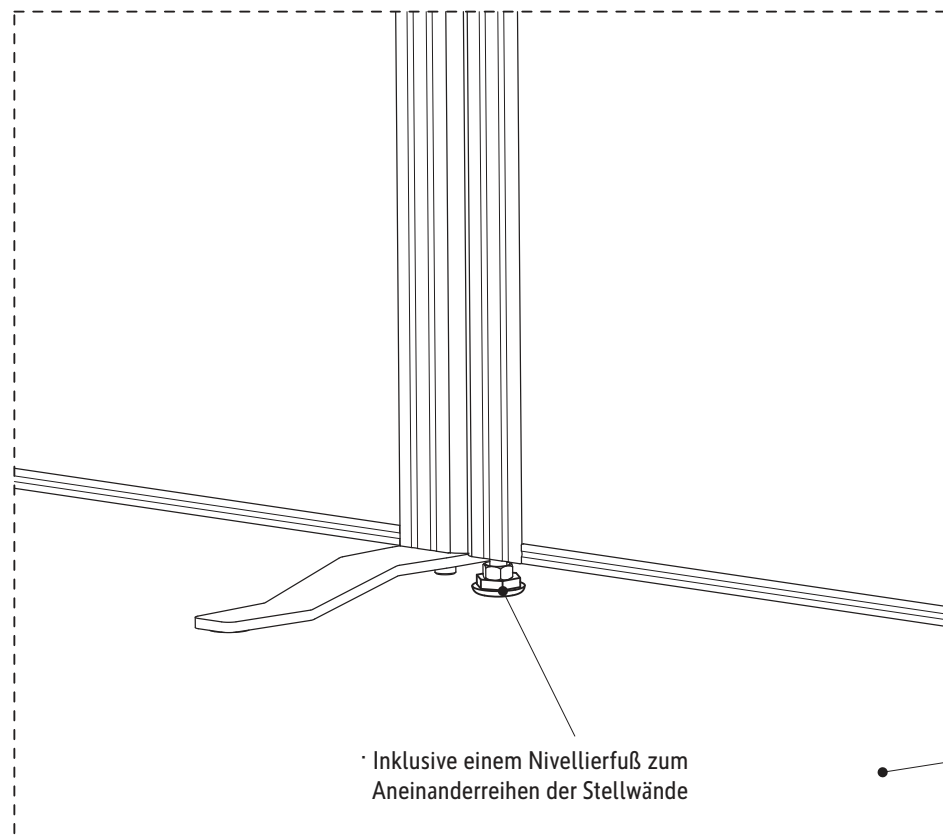

· Inklusive einem Nivellierfuß zum Aneinanderreihen der Stellwände

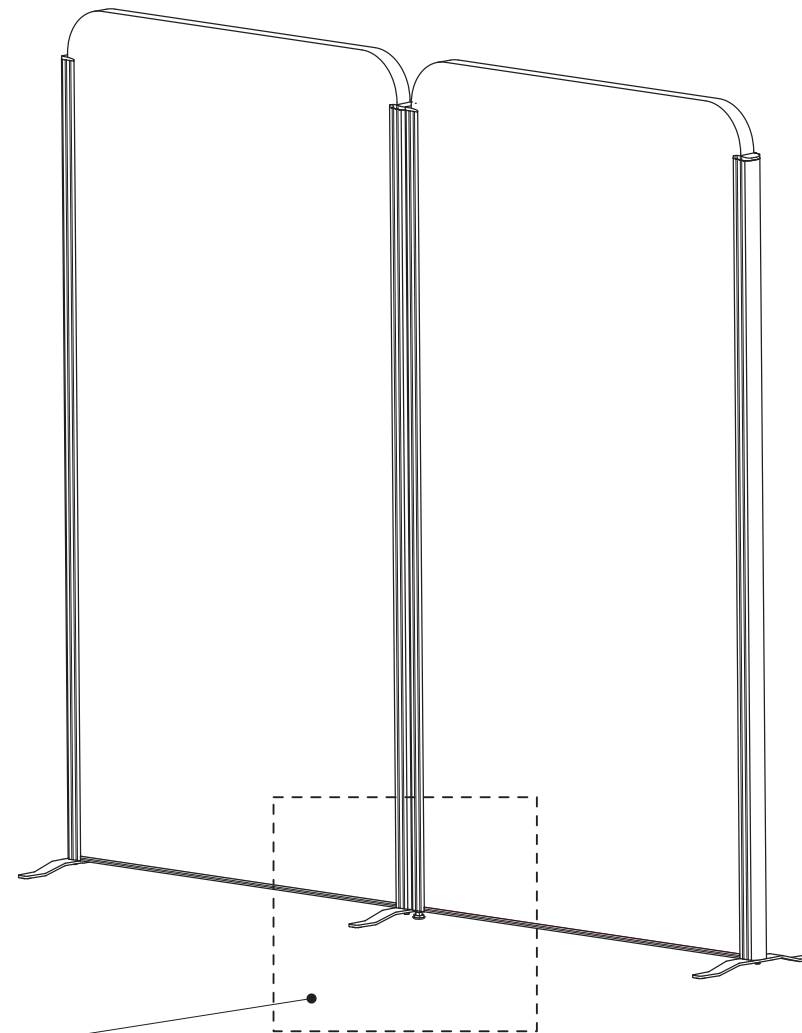

90° - 180° - 90°