

Technisches Datenblatt / Technical Datasheet

Art.-No. 61707

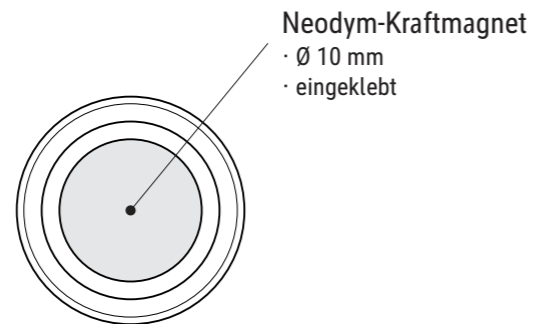
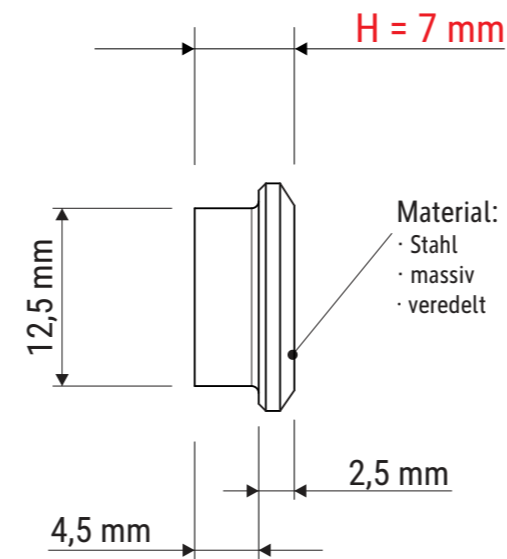
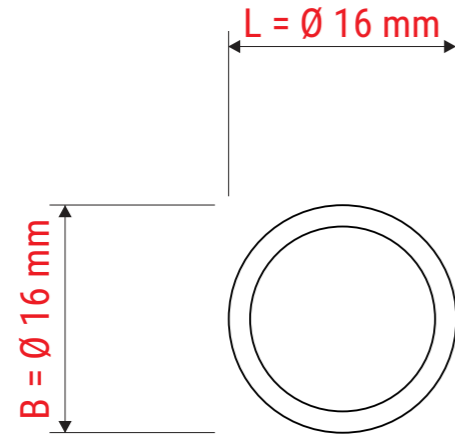

Haftkraft: 5 kg

Abmaße Produkt: **L x B x H**
16 x 16 x 7 mm
Gewicht: 0,008 kg

Verp. Abmaße : L x B x H (1 Stck. in der Blisterverpackung)
157 x 90 x 19 mm
Gewicht kompl.: 0,027 kg