

# Technisches Datenblatt / Technical Datasheet

## Art.-No. 21109



Art.-Nr.:  
2110990



Art.-Nr.:  
2110996

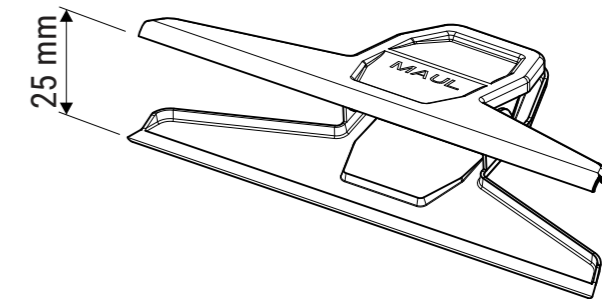
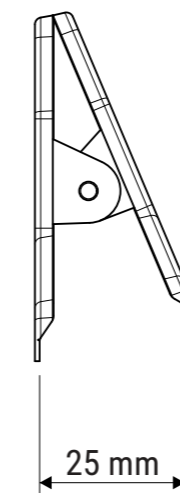
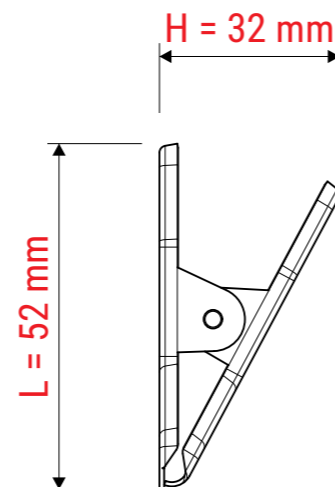
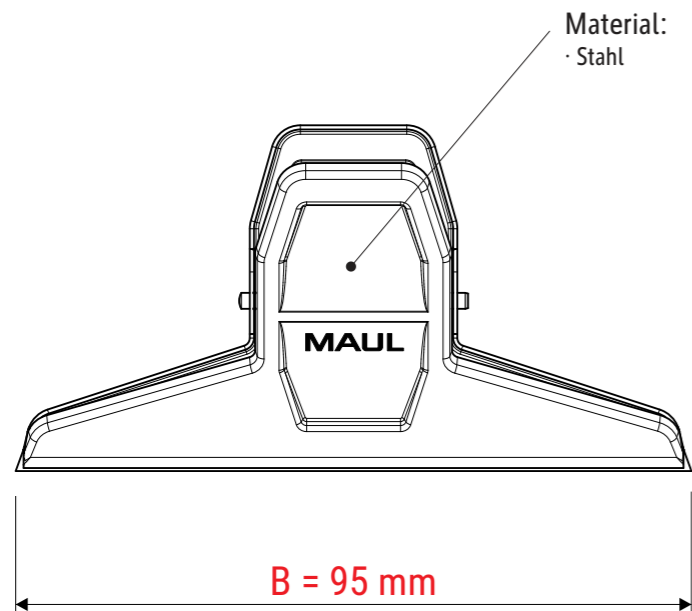

Klemmweite 25 mm

Abmaße Produkt: **L x B x H**  
52 x 95 x 32 mm  
Gewicht kompl.: 0,038 kg

Verp. Abmaße: L x B x H (2 Stck. im Folienbeutel + Kopfkarte)  
180 x 120 x 32 mm  
Gewicht kompl.: 0,081 kg