

Technisches Datenblatt / Technical Datasheet

Art.-No. 61810

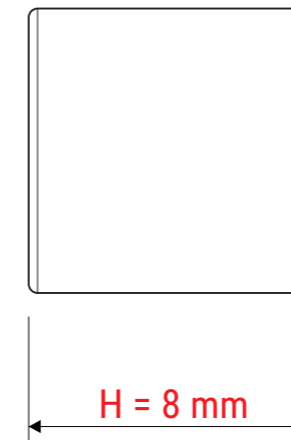
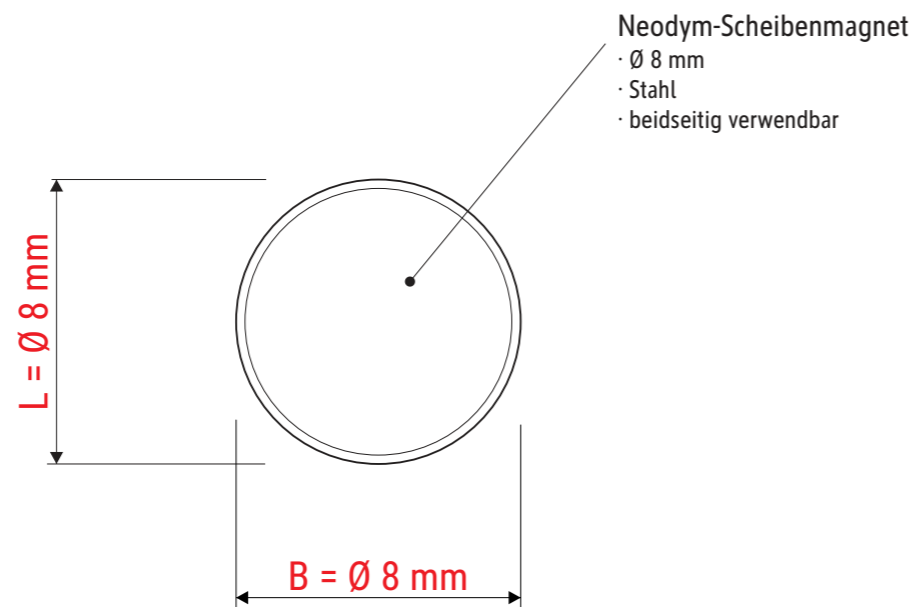

Haftkraft: 2,8 kg

Abmaße Produkt: **L x B x H**
8 x 8 x 8 mm
Gewicht: 0,003 kg

Verp. Abmaße : L x B x H (10 Stck. im Karton)
95 x 89 x 27 mm
Gewicht kompl.: 0,058 kg