

# Technisches Datenblatt / Technical Datasheet Art.-No. 82011

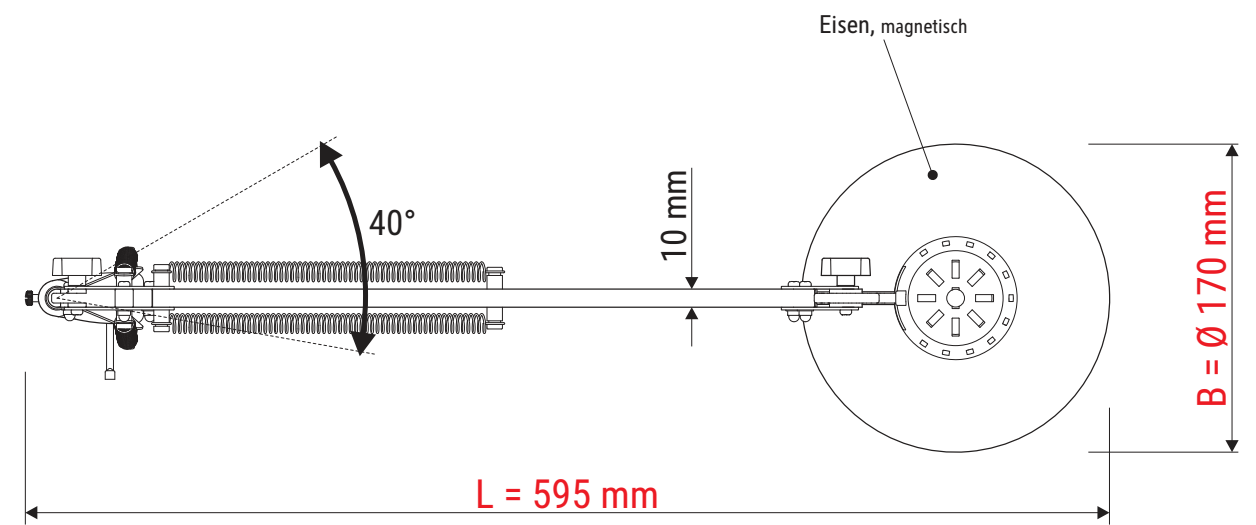
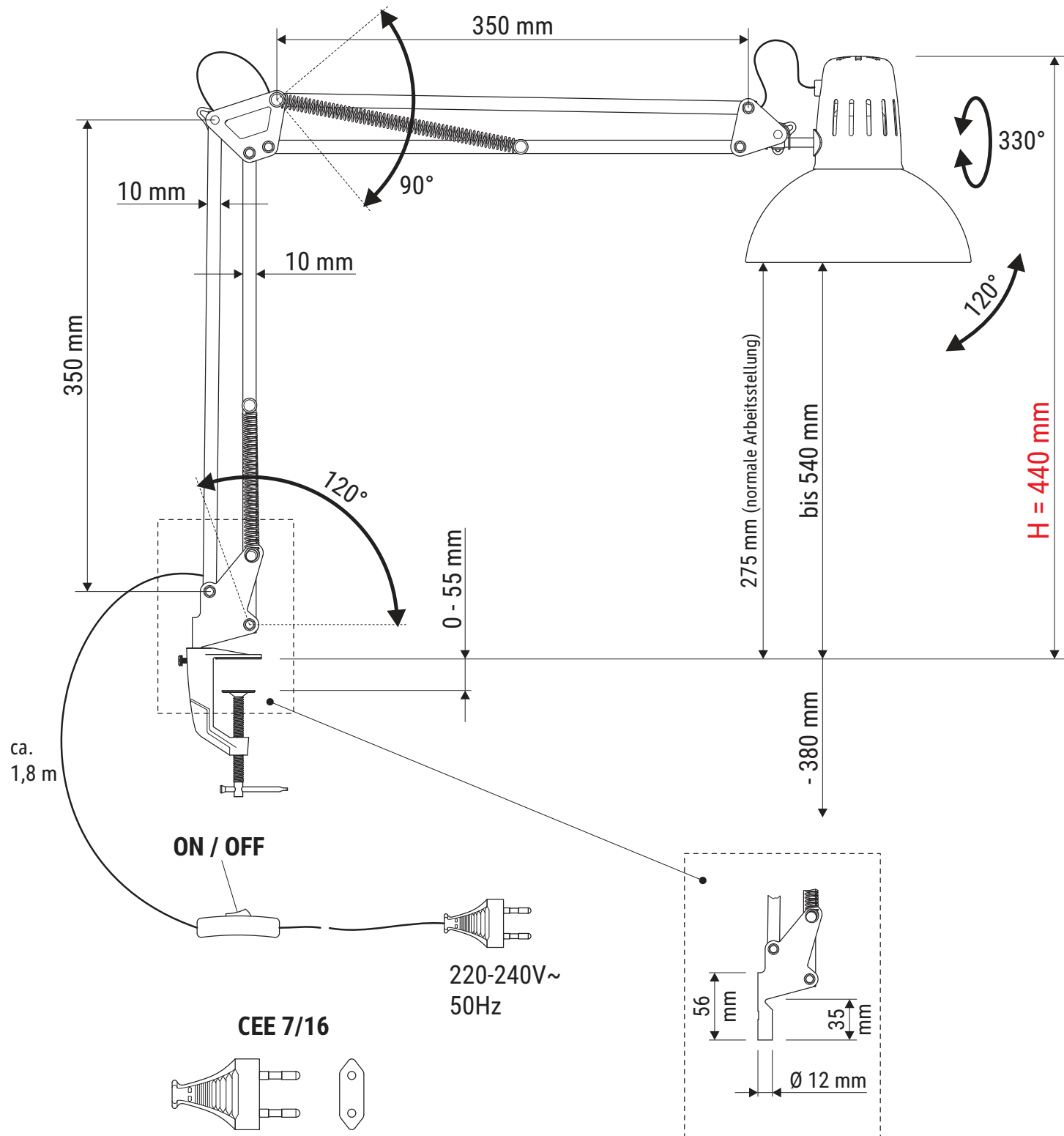

Abmaße Produkt: **L x B x H**  
595 x 170 x 440 mm (Arme senkrecht + waagrecht 90° zueinander)  
Gewicht: 0,850 kg

Verp. Abmaße : L x B x H  
460 x 265 x 100 mm  
Gewicht kompl.: 1,218 kg