

MAULgrace 820 50

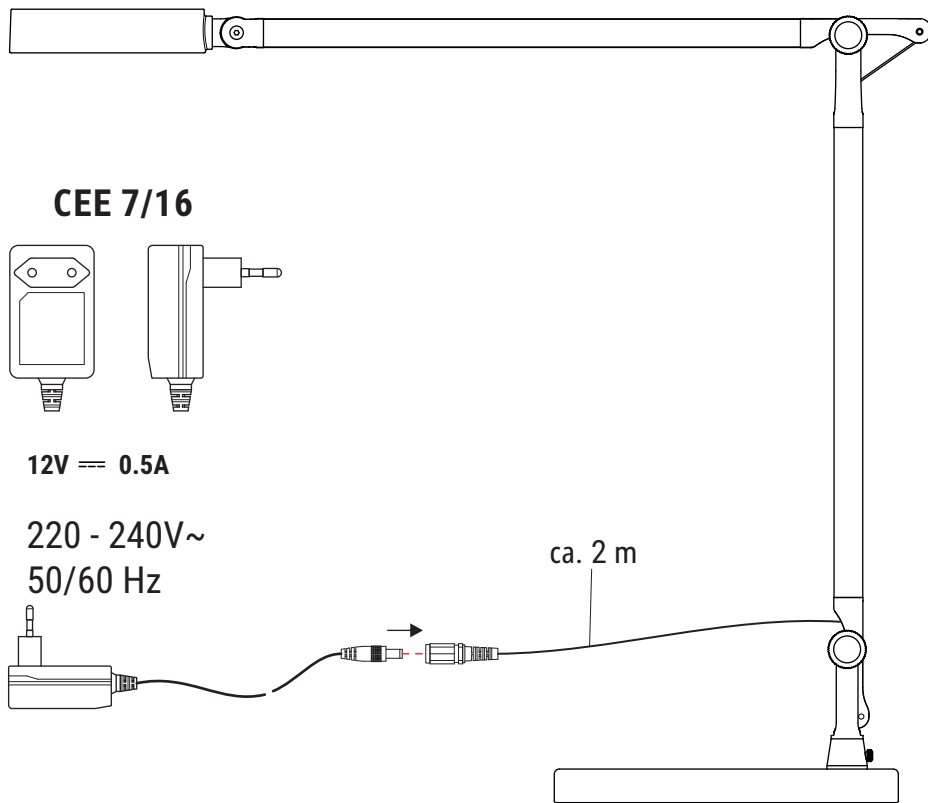

CEE 7/16

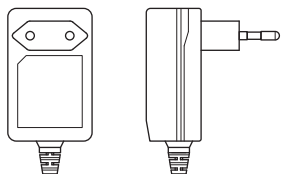

12V == 0.5A

220 - 240V~
50/60 Hz

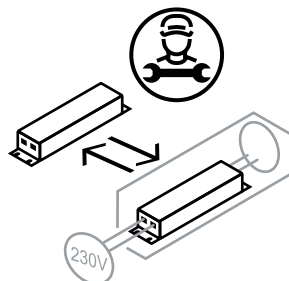
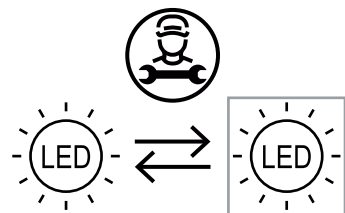

www.maul.de

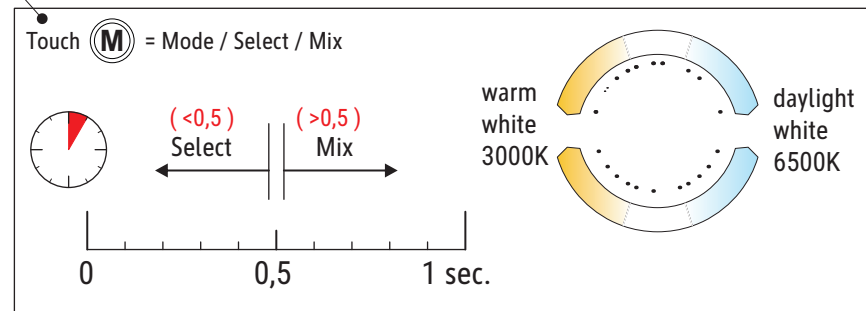
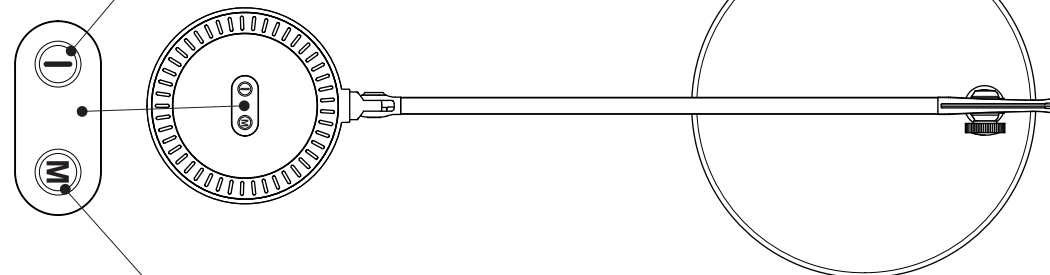
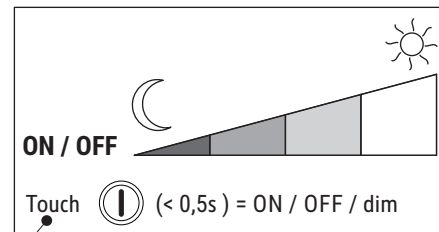

Memory - Funktion:

Alle Einstellungen werden beim Ausschalten (ⓘ >0,5 s) automatisch gespeichert! Voraussetzung: Dauerhafte Netzspannung!

Memory function:

All adjustments are automatically saved when the lamp is switched off (ⓘ >0,5s)! Requirement: continuous mains voltage!

Fonction mémoire:

Tous les réglages sont automatiquement sauvegardés lorsqu'on éteint (ⓘ >0,5s) le luminaire! Condition: tension de réseau continue!



Notice de conditionnement et d'élimination
Istruzioni di imballaggio e smaltimento
Опаковка и указание за изхвърляне



8205009.150K

- DE: Dieses Produkt enthält eine Lichtquelle der Energieeffizienzklasse < F >
- BG: Този продукт съдържа един светлинен източник от клас на енергийна ефективност < F >
- CZ: Tento výrobek obsahuje světelný zdroj s třídou energetické účinnosti < F >
- DK: Dette produkt indeholder en lyskilde i energieffektivitetsklasse < F >
- ES: Este producto contiene una fuente luminosa de la clase de eficiencia energética < F >
- EE: Nimetatud toode sisaldab energiatõhususe klassi < F > kuuluvat valgusallikat
- FI: Tämä tuote sisältää valonlähteen, jonka energiatehokkuusluokka on < F >
- FR: Ce produit contient une source lumineuse de classe d'efficacité énergétique < F >
- GB: This product contains a light source of energy efficiency class < F >
- GR: Αυτό το προϊόν περιέχει μια πηγή φωτός με κλάση ενεργειακής απόδοσης < F >
- HR: Ovaj proizvod sadrži izvor svjetlosti s klasom energetske učinkovitosti < F >
- HU: Ez a termék egy darab, < F > energiatékonyági osztályba sorolt fényforrást tartalmaz
- IT: Questo prodotto contiene una sorgente luminosa di classe di efficienza energetica < F >
- LT: Šiame gaminyje yra šviesos šaltinis, kurio energijos vartojimo efektyvumo klasė yra < F >
- LV: Šis ražojums satur gaismas avotu, kura energoefektivitātes klase ir < F >
- NL: Dit product bevat een lichtbron van energie-efficiëntieklasse < F >
- NO: Dette produktet inneholder en lyskilde i energiklasse < F >
- PL: Ten produkt zawiera źródło światła o klasie efektywności energetycznej < F >
- PT: Este produto contém uma fonte de luz da classe de eficiência energética < F >
- RO: Acest produs conține o sursă de lumină din clasa de eficiență energetică < F >
- RS: Ovaj proizvod sadrži izvor svetlosti sa klasom energetske efikasnosti < F >
- RU: В данном изделии используется источник света с классом энергоэффективности < F >
- SE: Denna produkt innehåller en ljuskälla med energieffektivitetsklass < F >
- SK: Tento výrobok obsahuje svetelný zdroj triedy energetickej účinnosti < F >
- SI: Ta izdelek vsebuje svetlobni vir razreda energijske učinkovitosti < F >
- TR: Bu ürün < F > enerji verimlilik sınıfında bir ışık kaynağı içerir
- UA: Цей виріб містить джерело світла з класом енергоспоживання < F >

Ersatzteile (spare parts):

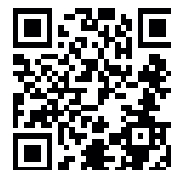
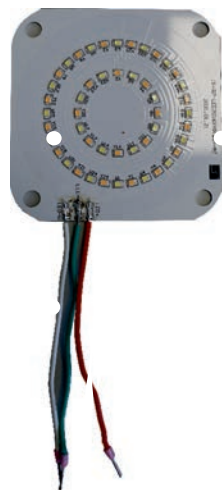

Art.-No.: 8205009.200

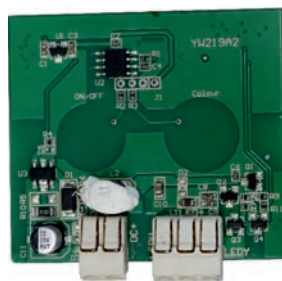

Art.-No.: 8205009.220



Art.-No.: 8205009.215

Art.-No.:
8205009.220

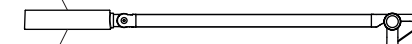

Art.-No.:
8205009.200

Art.-No.:
8205009.215

