

Technisches Datenblatt / Technical Datasheet

Art.-No. 61668

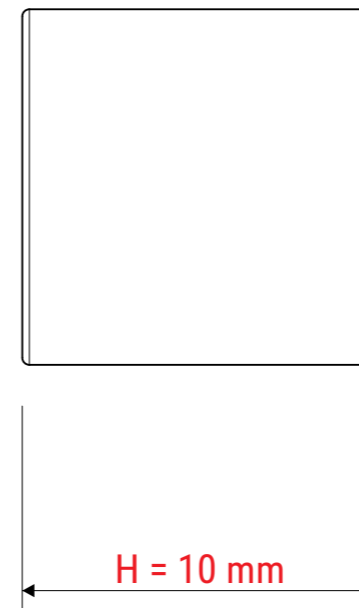
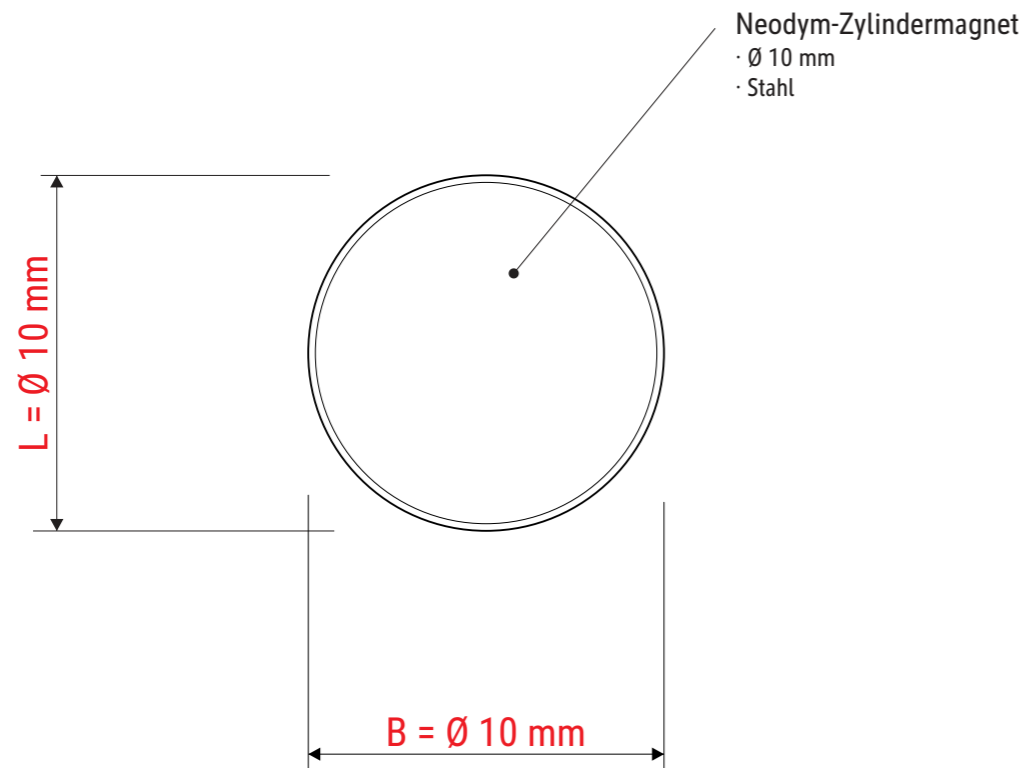

Haftkraft: 4 kg

Abmaße Produkt: **L x B x H**
10 x 10 x 10 mm
Gewicht: 0,006 kg

Verp. Abmaße : L x B x H (4 Stck. im Karton)
95 x 85 x 30 mm
Gewicht kompl.: 0,047 kg