

Technisches Datenblatt / Technical Datasheet

Art.-No. 82056

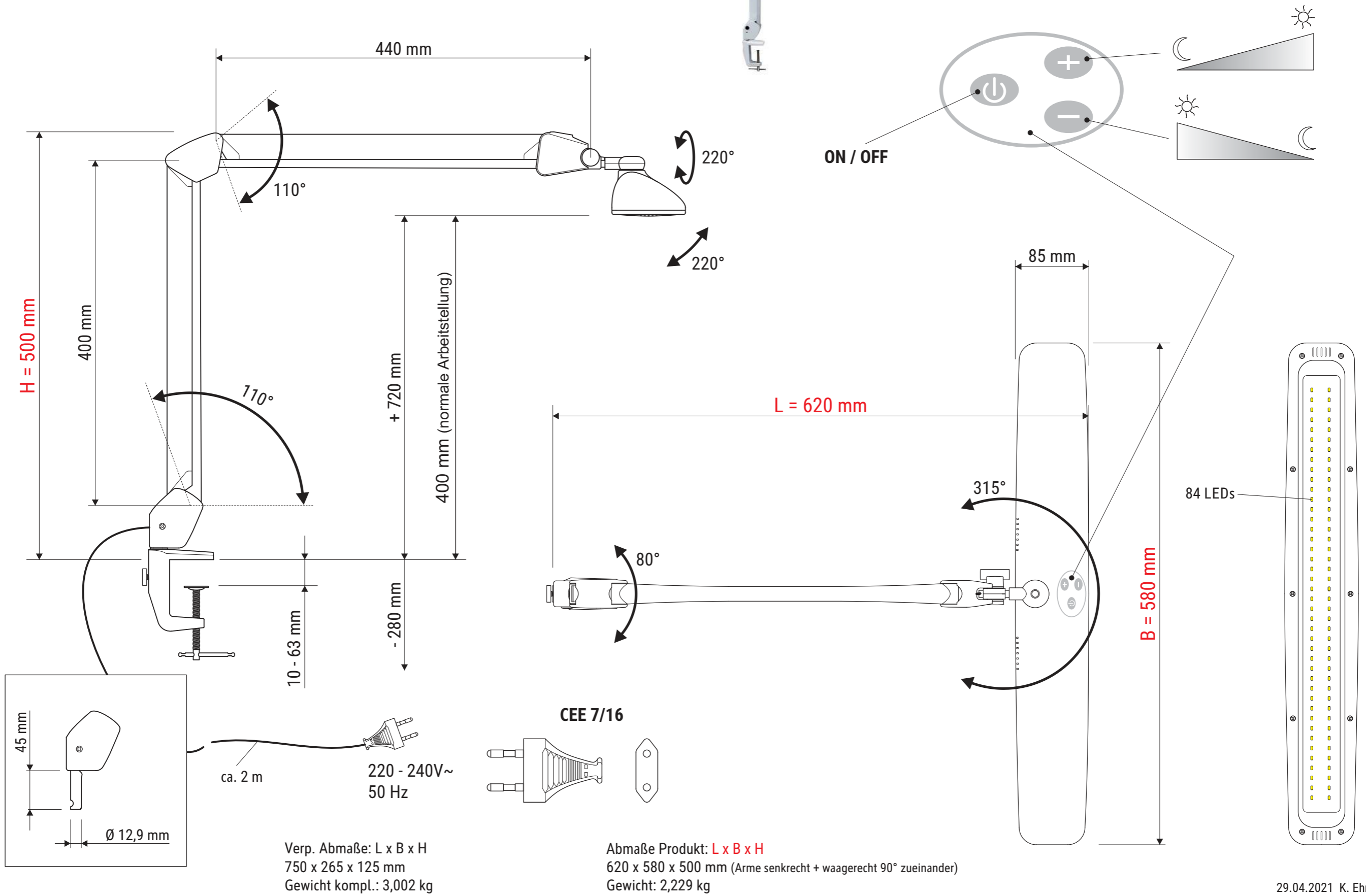

Verp. Abmaße: L x B x H
750 x 265 x 125 mm
Gewicht kompl.: 3,002 kg

Abmaße Produkt: **L x B x H**
620 x 580 x 500 mm (Arme senkrecht + waagrecht 90° zueinander)
Gewicht: 2,229 kg