

Technisches Datenblatt / Technical Datasheet

Art.-No. 61656



Art.-Nr.
6165602

Art.-Nr.
6165625

Art.-Nr.
6165635

Art.-Nr.
6165655

Art.-Nr.
6165690

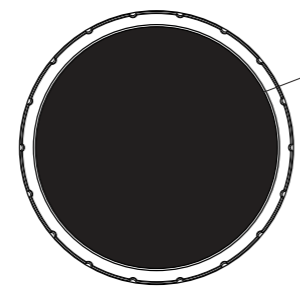
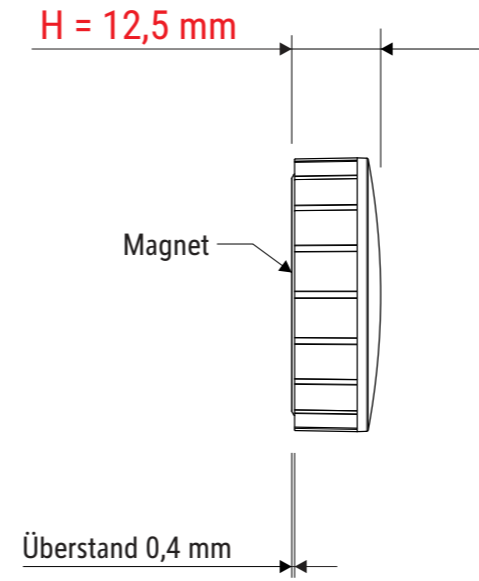
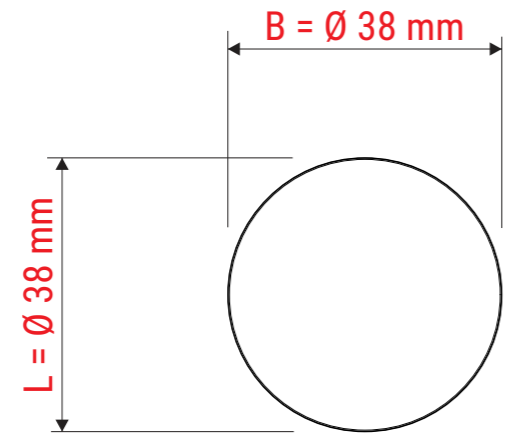

Magnet:
· Ø 34 x 9 mm
· sauber mit Kunststoffgehäuse verklebt

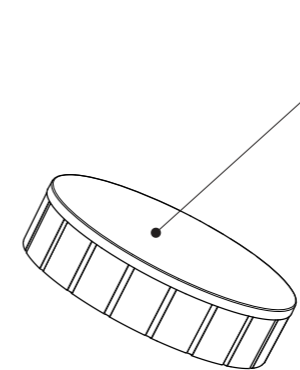

Gehäuse:
· zart gewölbt
· bruchsicherer Kunststoff
· Oberfläche leicht erodiert
· Seite mit vertikalen Rillen

Haftkraft: 1,5 kg

Abmaße Produkt: **L x B x H**
38 x 38 x 12,5 mm
Gewicht: 0,0405 kg

Verp. Abmaße : L x B x H (4 Stck. in SB-Verp.)
155 mm x 100 mm x 15 mm
Gewicht kompl.: 0,1757 kg