

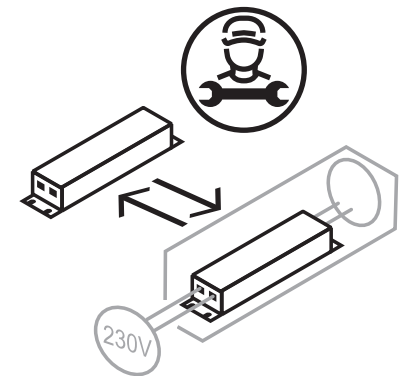

Art.-No.: 8200409.200

Art.-No.: 8200409.210

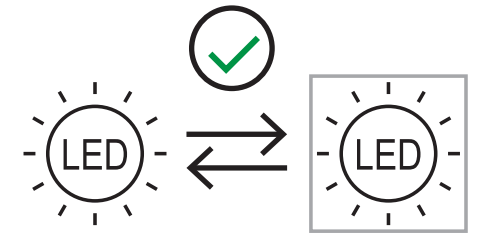

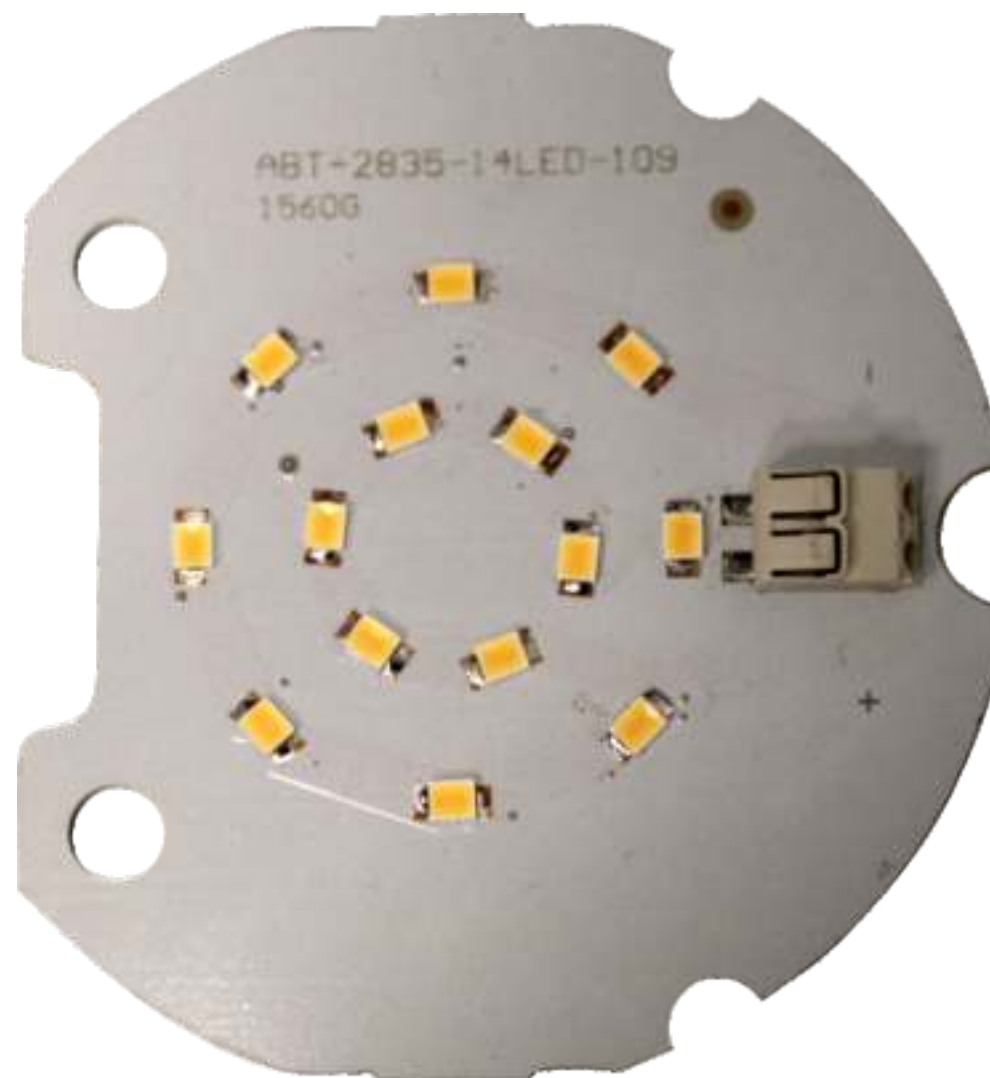
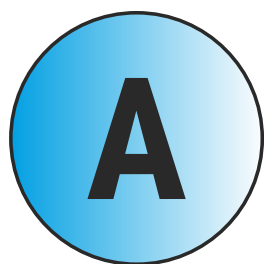

Art.-No.: 8200409.200

1

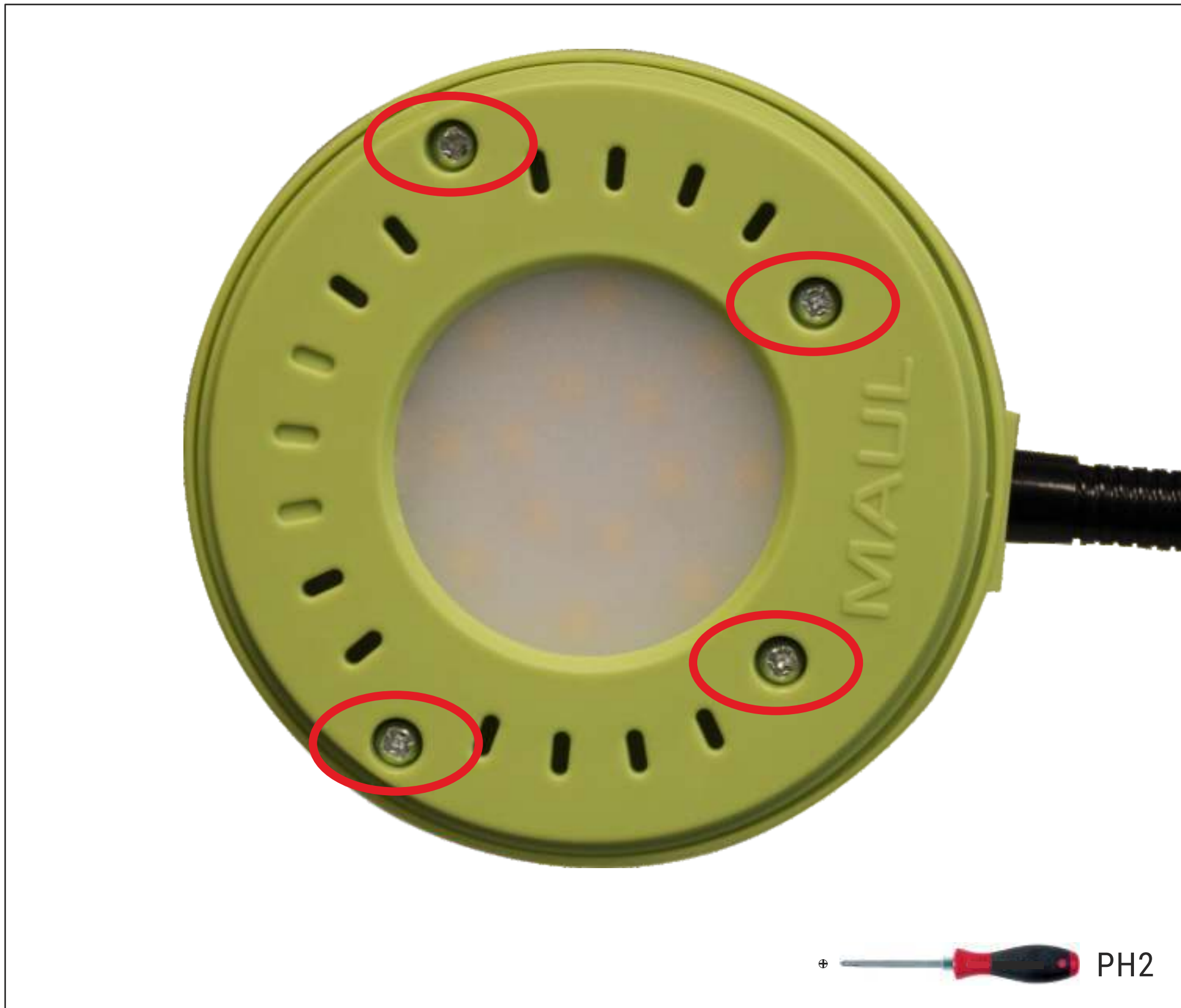

2

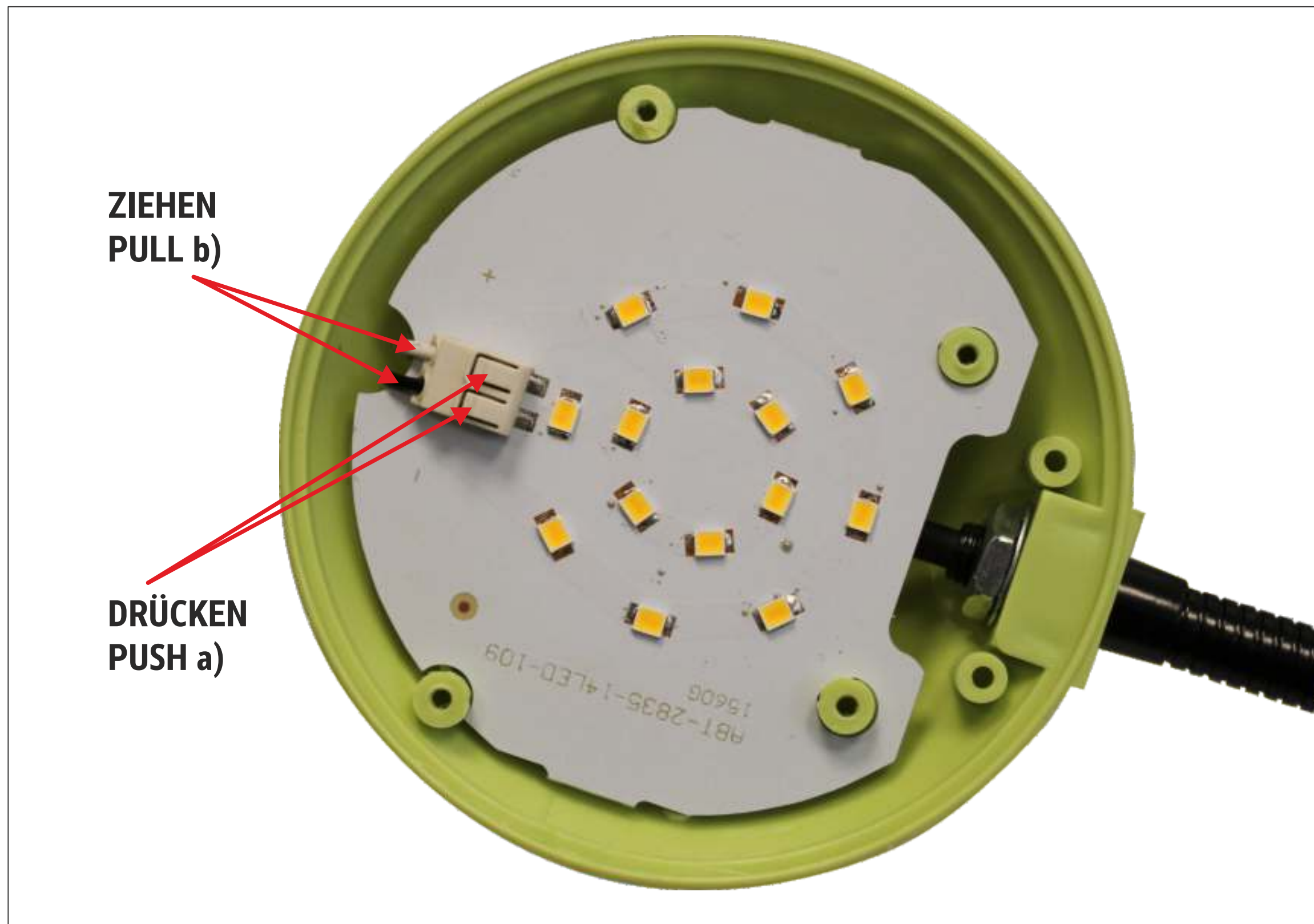

B

1 x

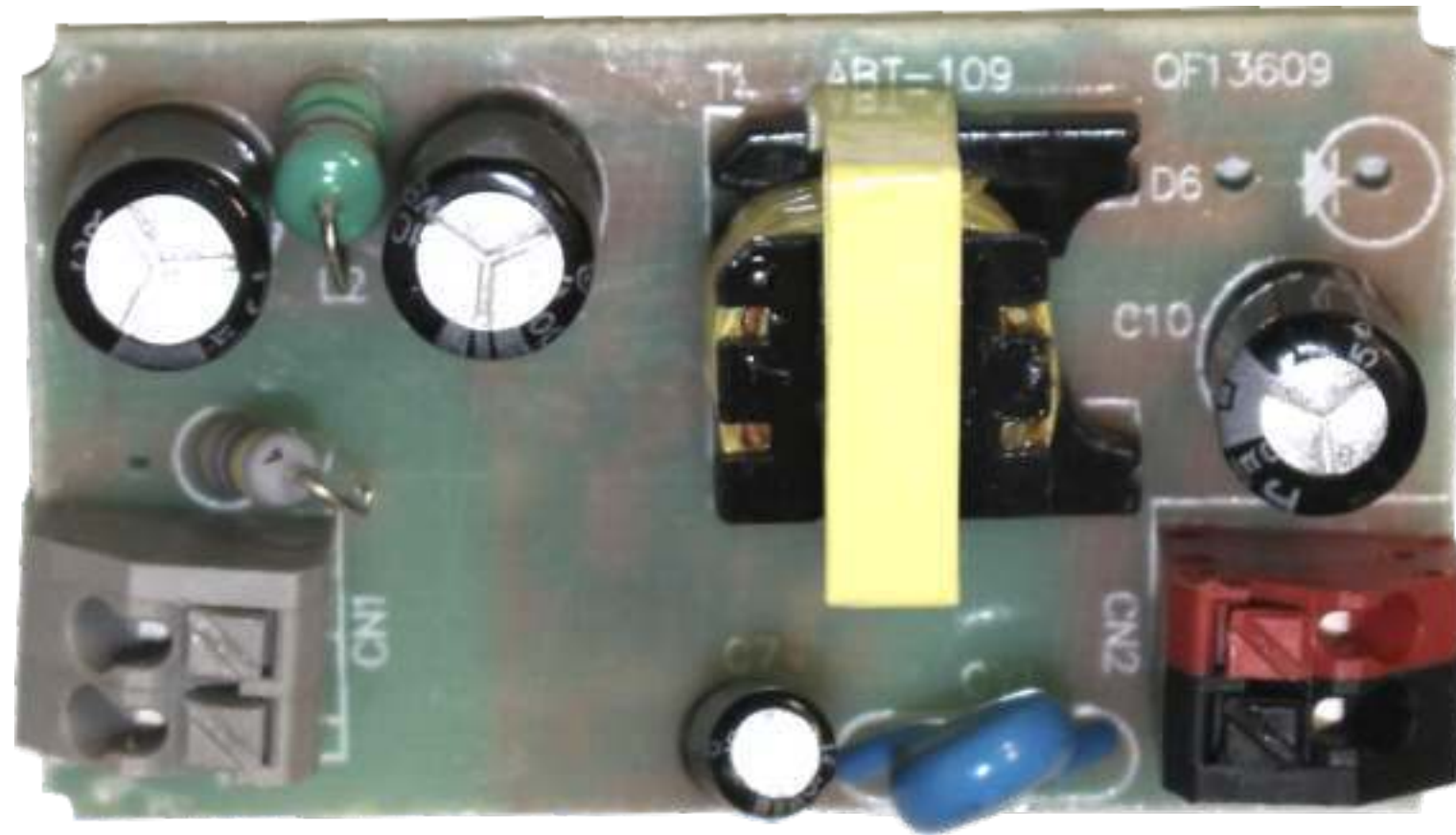

4 x

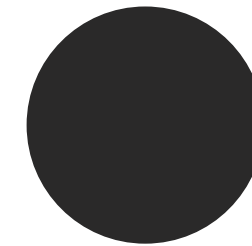

Art.-No.: 8200409.210

1

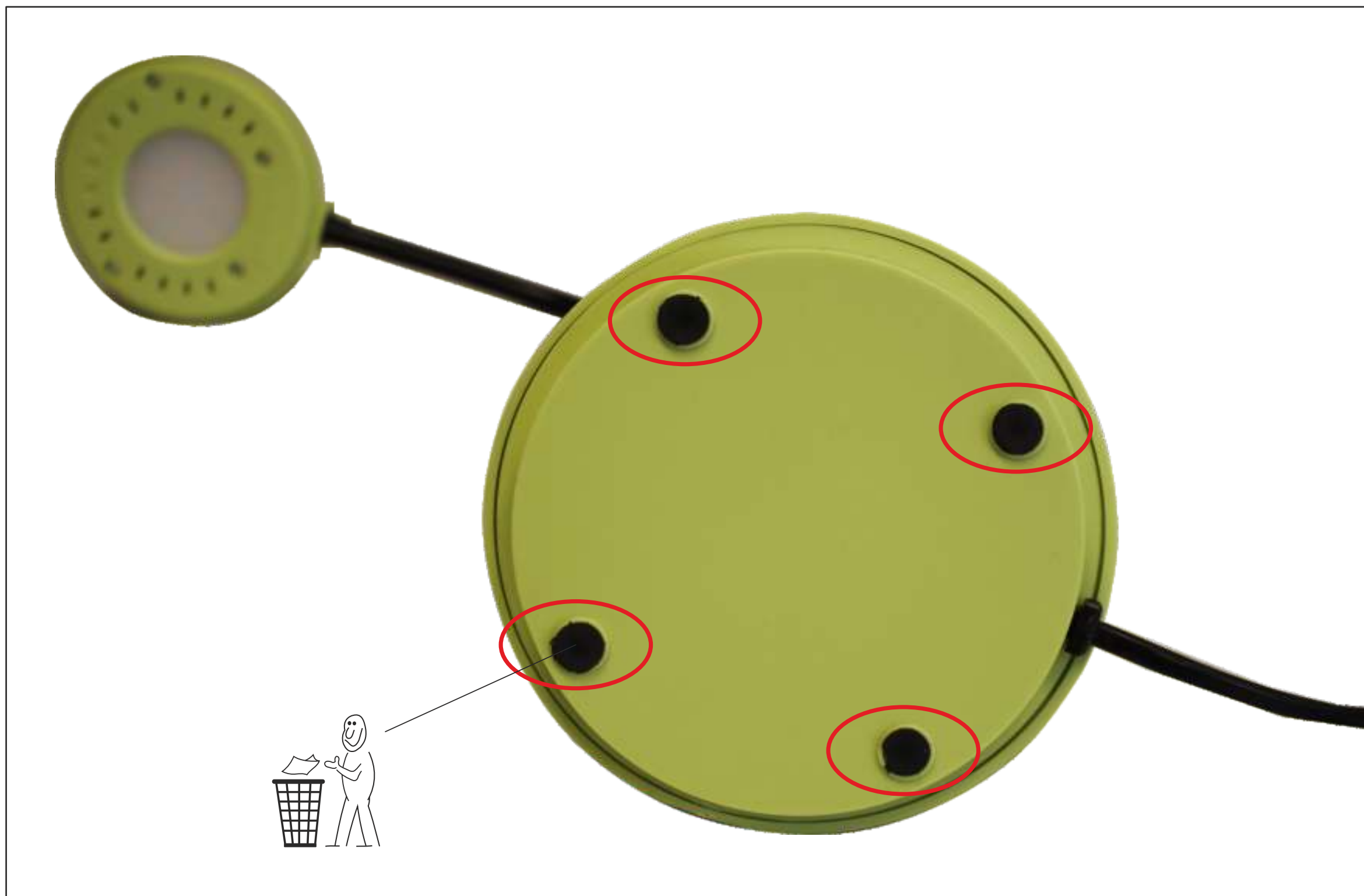

2



3

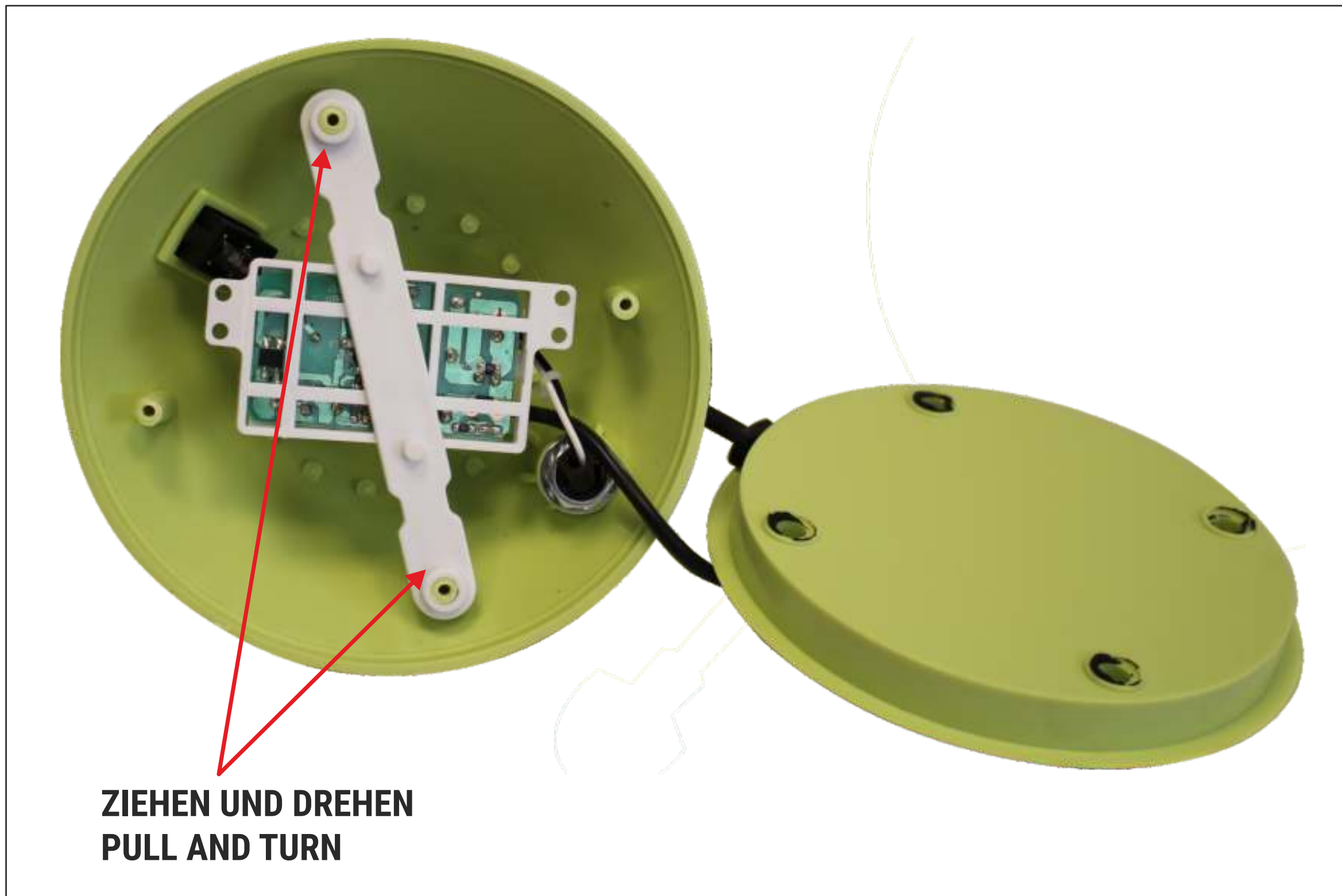

4

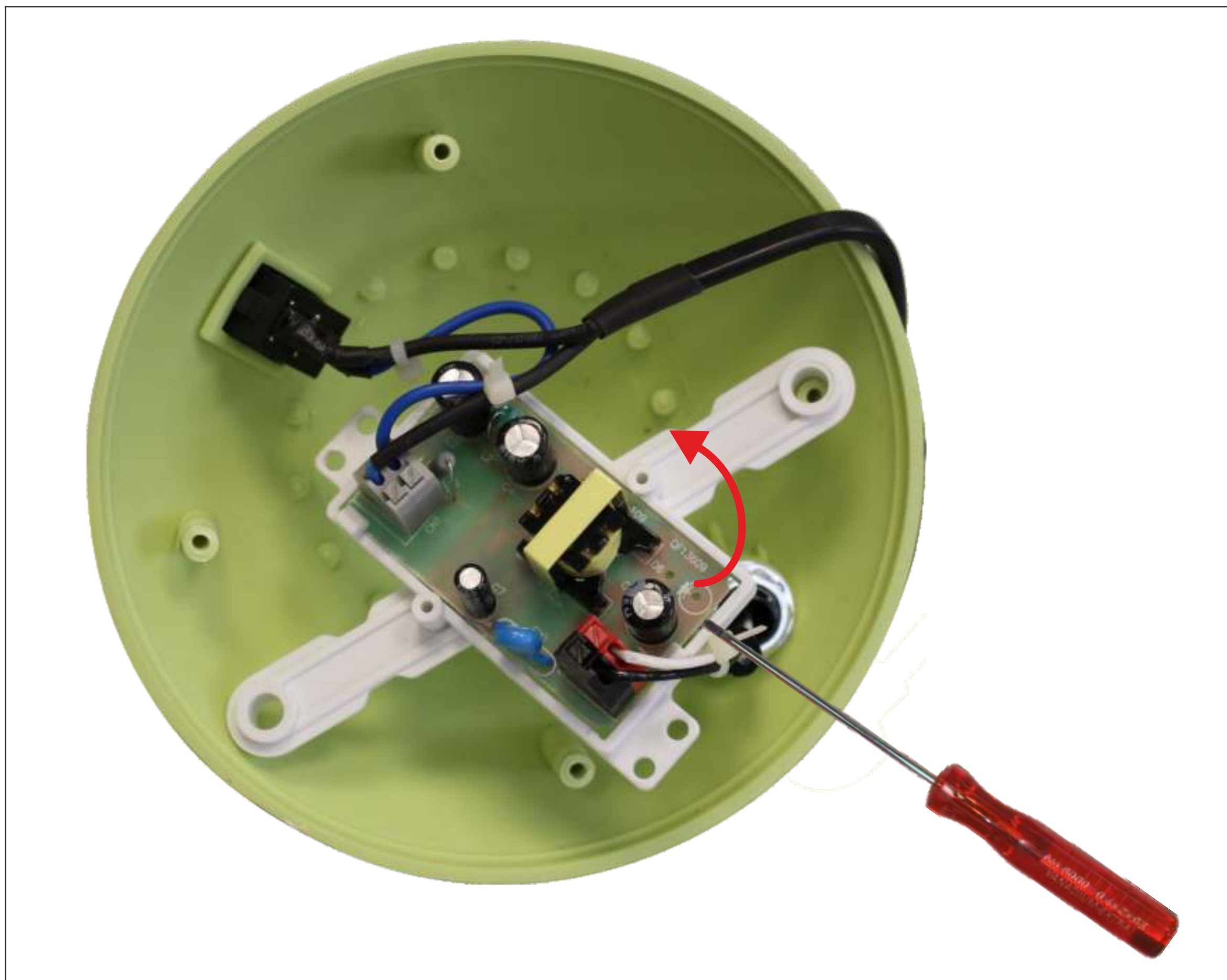

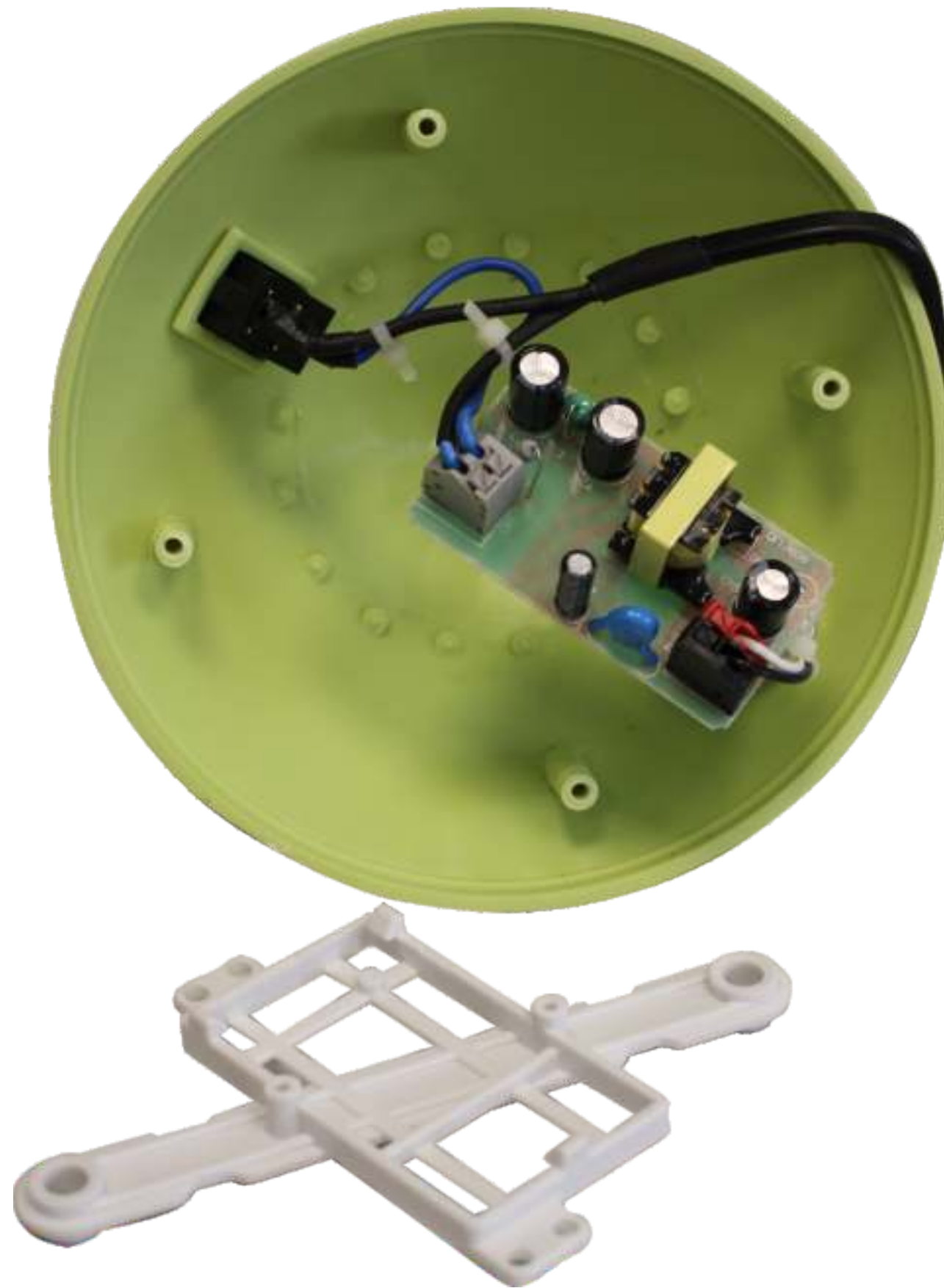

5

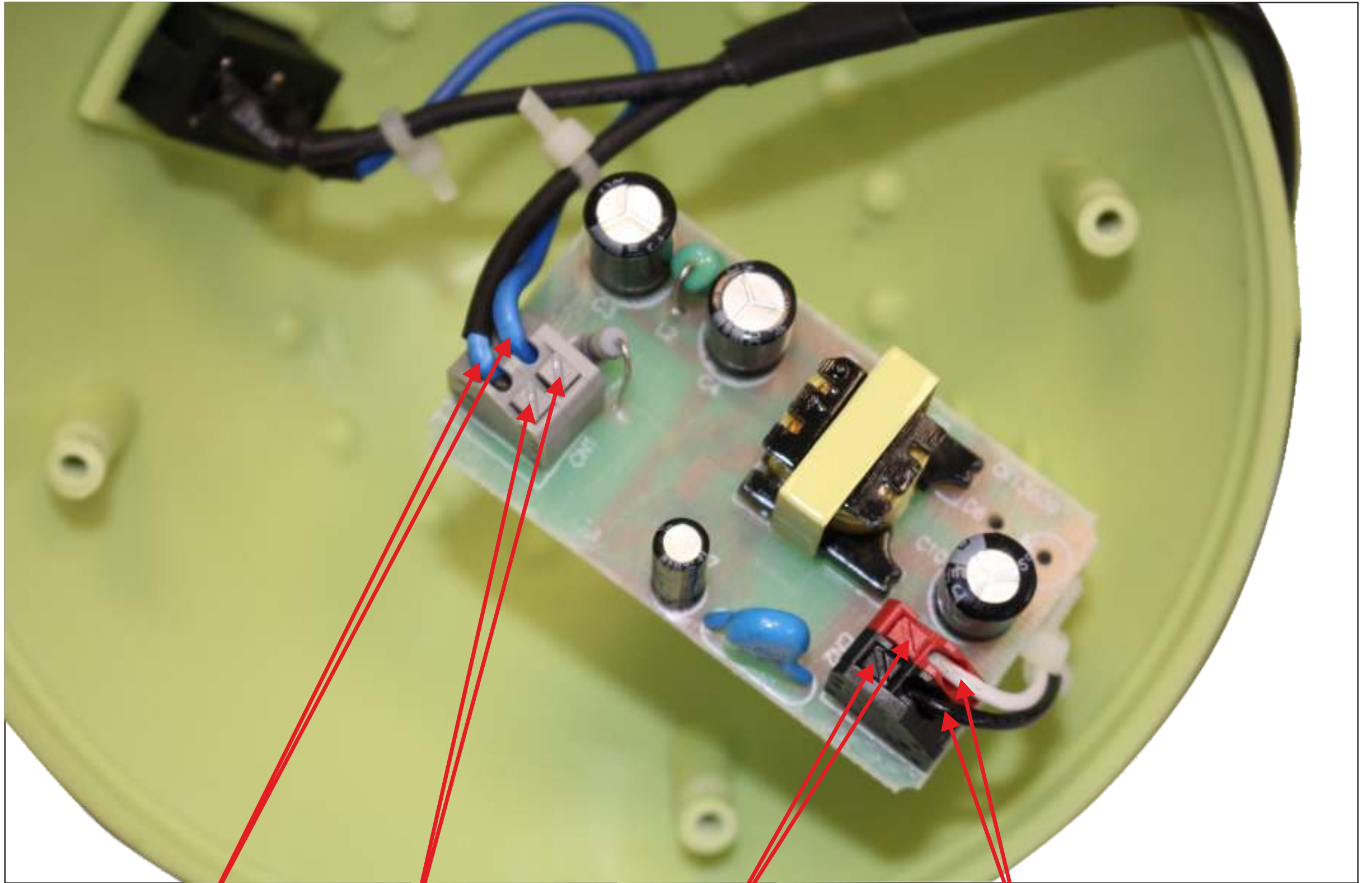

PULL b)

PUSH a)

PUSH a)

PULL b)