

Technisches Datenblatt / Technical Datasheet

Art.-No. 61578

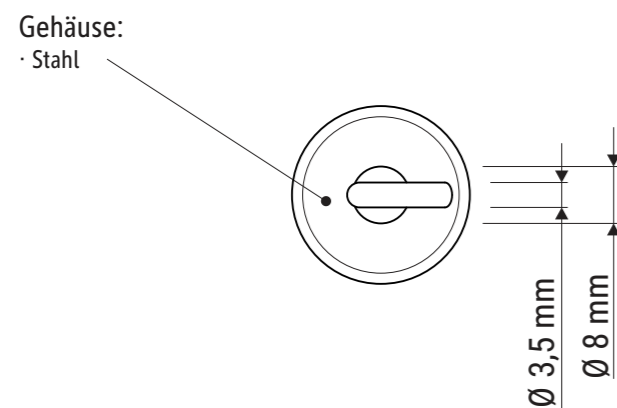

Haftkraft: 3 kg

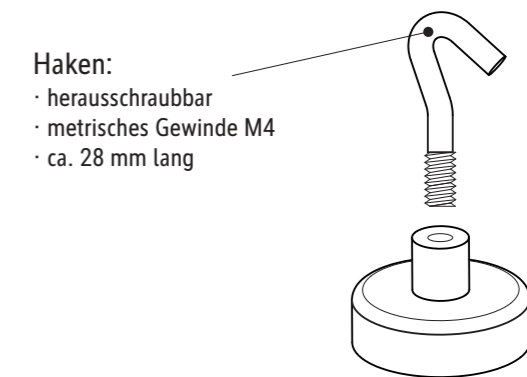
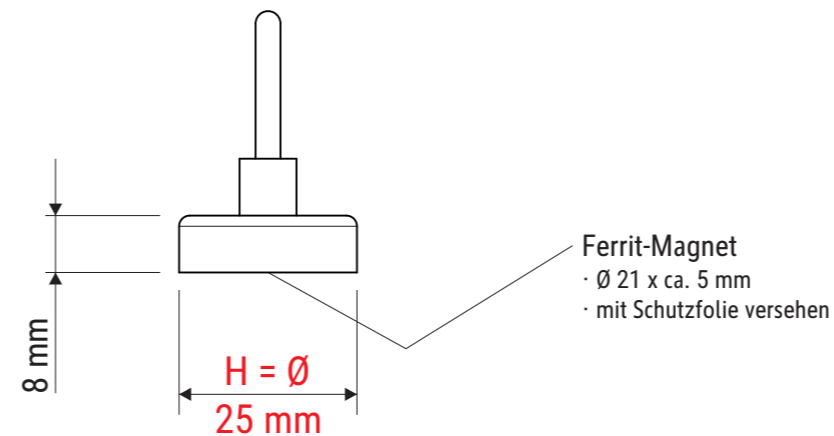
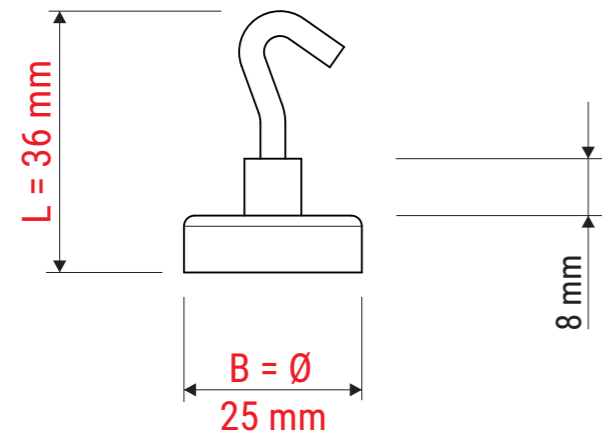
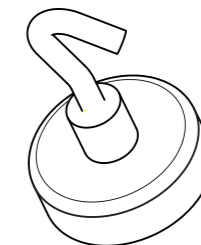

Abmaße Produkt: **L x B x H**
 36 x 25 x 25 mm
 Gewicht: 0,027 kg

Verp. Abmaße : L x B x H (5 Stck. im Karton)
 128 x 37 x 41 mm
 Gewicht kompl.: 0,164 kg