

Technisches Datenblatt / Technical Datasheet

Art.-No. 68204



Abmaße Produkt: **L x B x H**
 31 x 490 x 651 mm
 Gewicht kompl.: 2,390 kg

Verp. Abmaße: L x B x H
 740 x 580 x 85 mm
 Gewicht kompl.: 3,240 kg

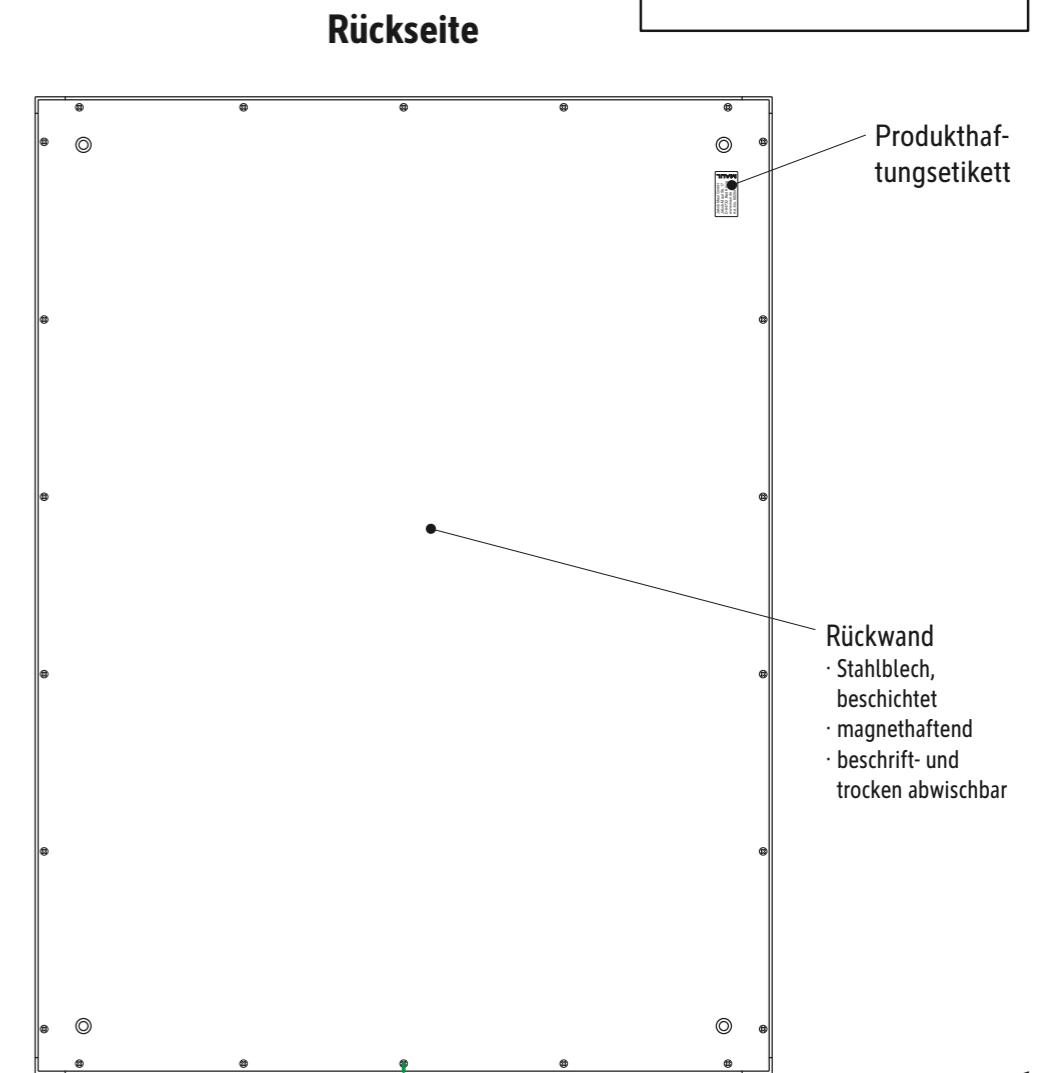
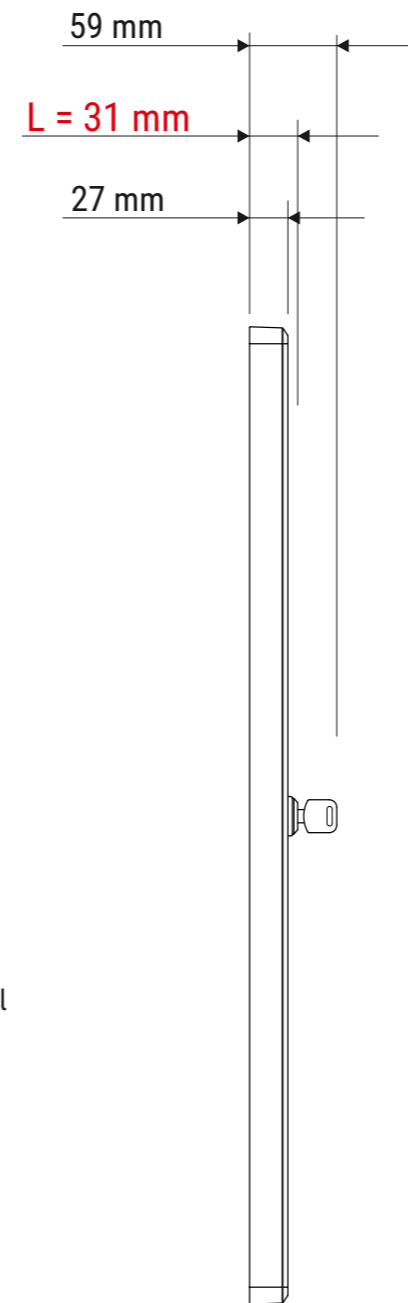
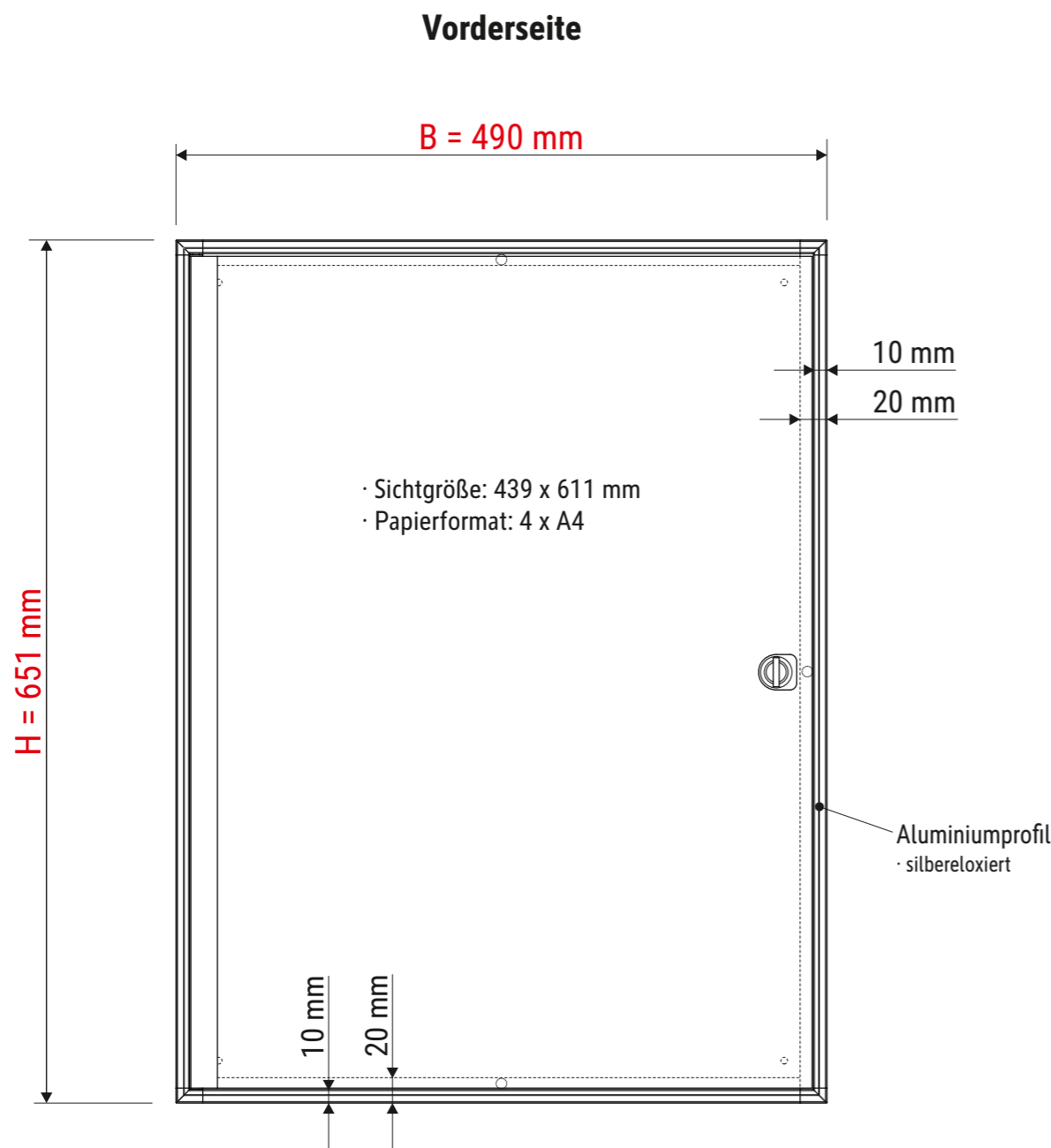
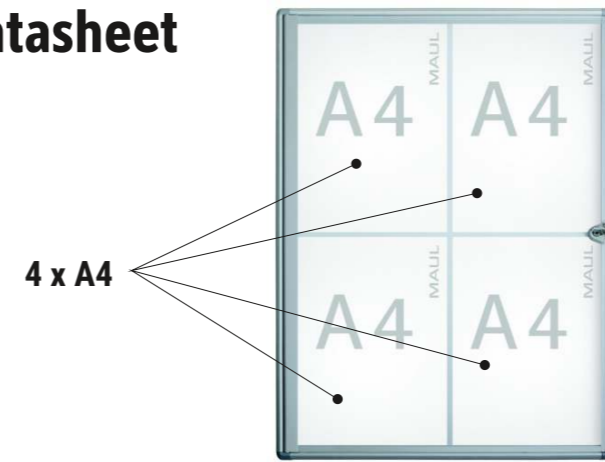

Technisches Datenblatt / Technical Datasheet

Art.-No. 68204

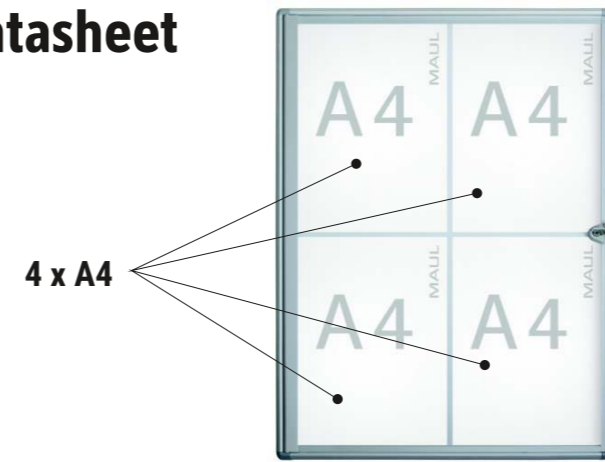

· Innentiefe 9 mm

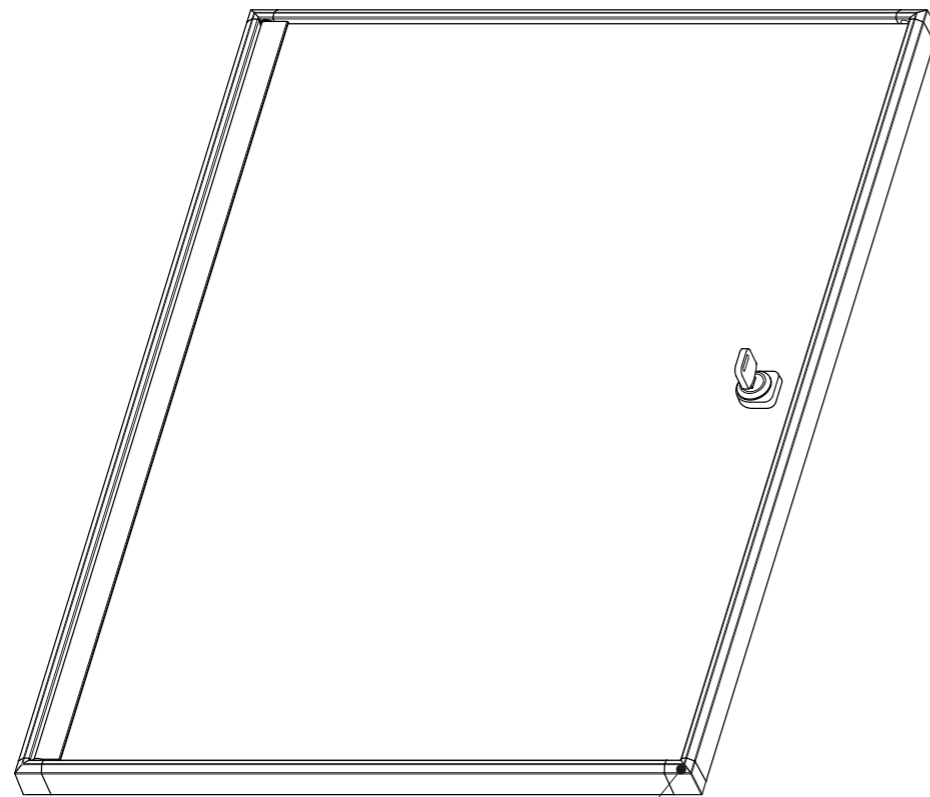

Eckverbindungen
· abgeschrägt
· Kunststoff

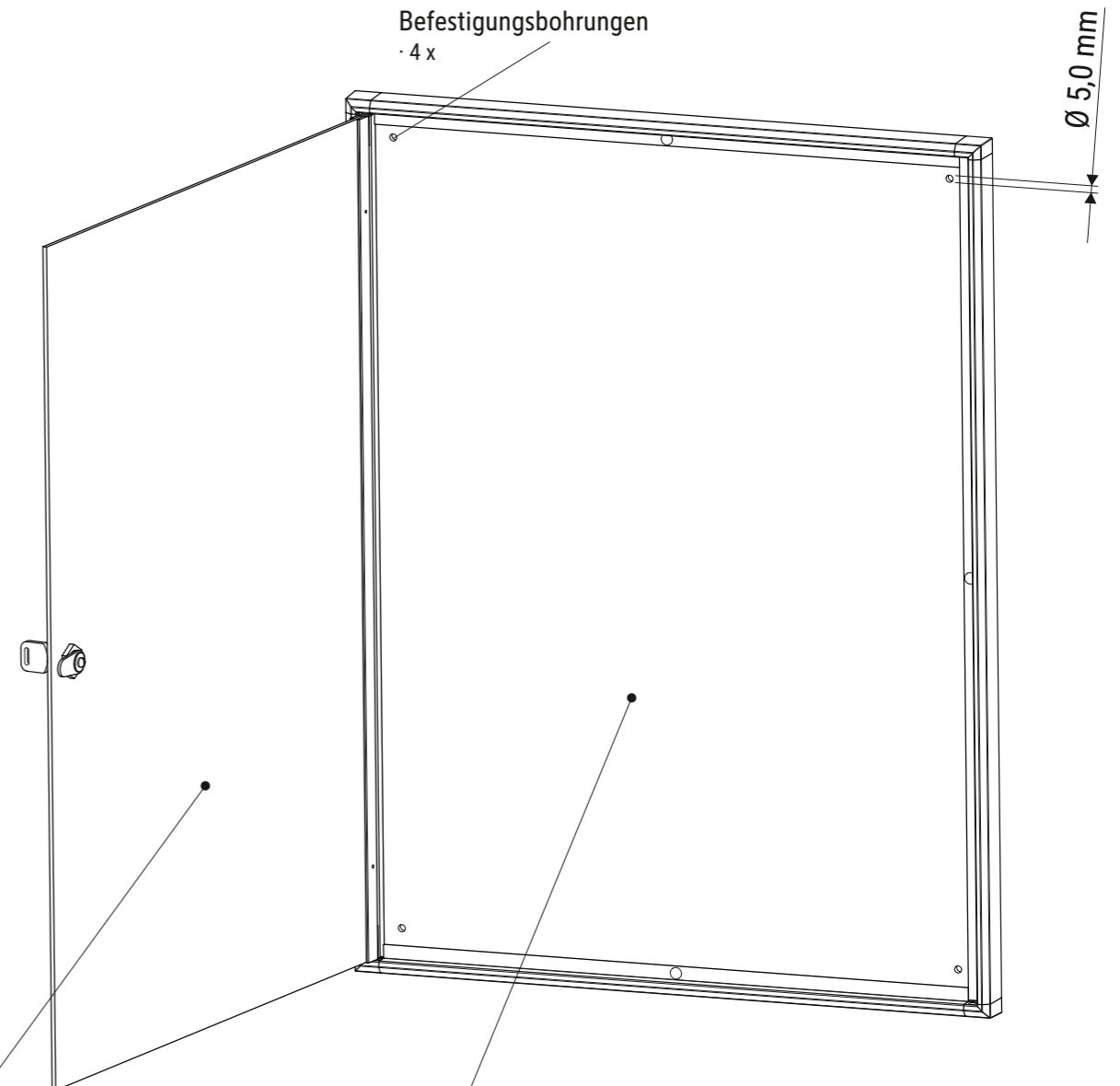

Befestigungsbohrungen
· 4 x

Ø 5,0 mm

Flügel
· rahmenlos
· Kunststoffglas
· mit integriertem Schloss

Stahlblech
· magnethaftend,
· beschrift- und trocken abwischbar