

**Technisches Datenblatt /
Technical Datasheet
Art.-No. 56114**



Art.-Nr.:
5611402



Art.-Nr.:
5611425



Art.-Nr.:
5611437



Art.-Nr.:
5611490



Art.-Nr.:
5611495

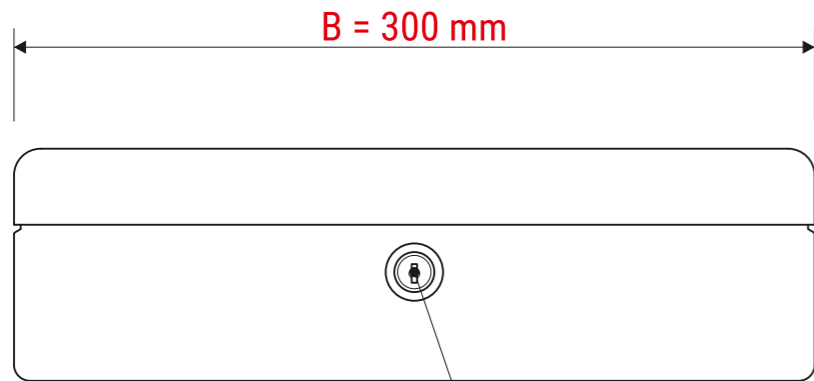

Sicherheitszylinderschloss
mit 2 Schlüsseln

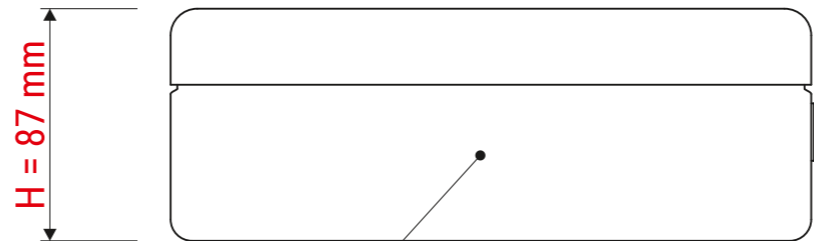

- lackierter Stahl
- nahtlos gezogen
- Innenmaße: 291 x 215 x 60 mm

stabiler Griff

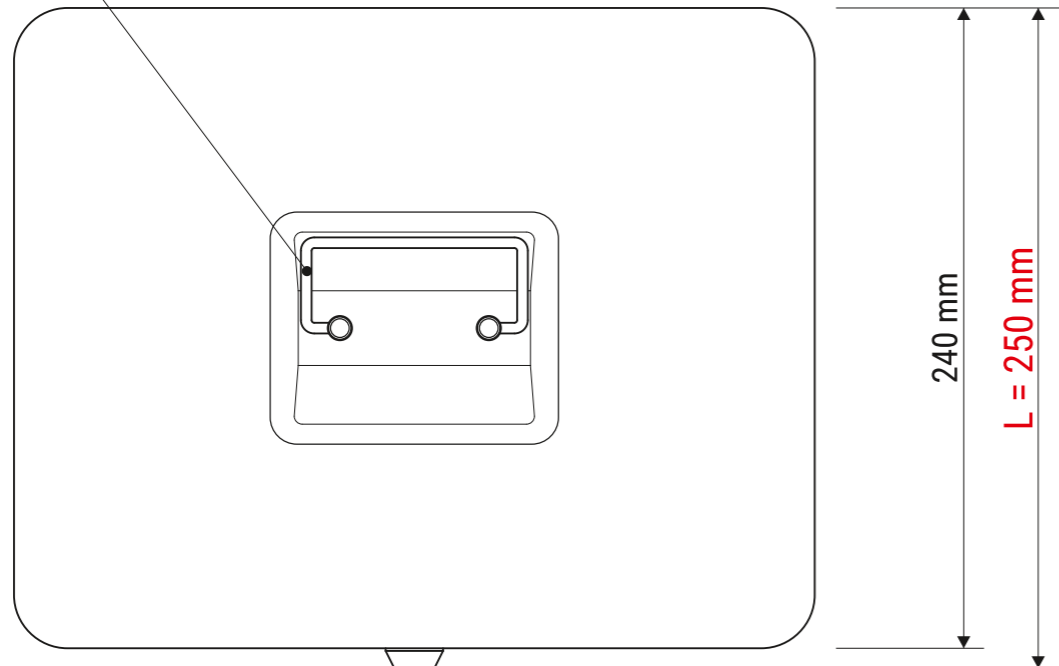

Münzgeldeinsatz
· 291 x 232 x 30 mm
· Kunststoff

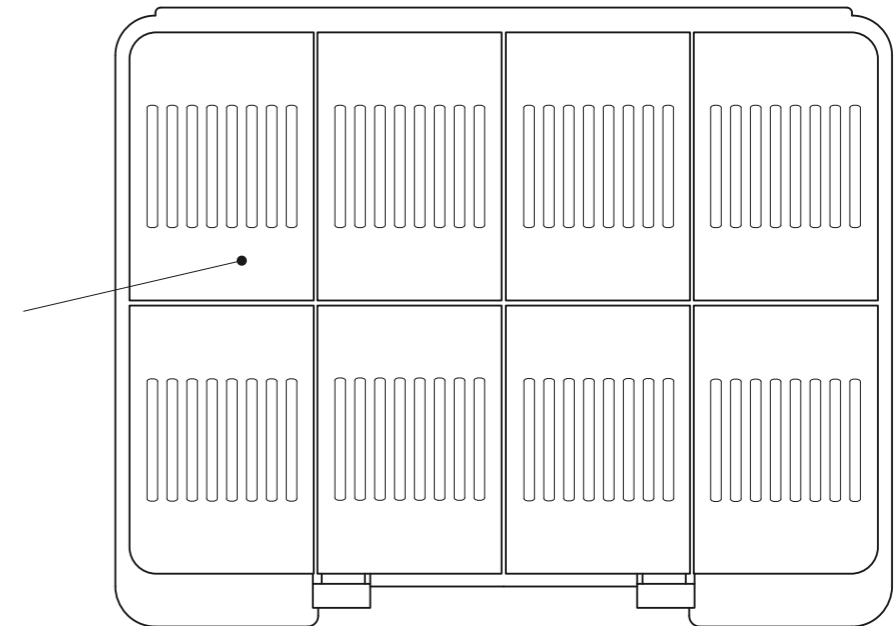

Abmaße Produkt: **L x B x H**
250 x 300 x 87 mm
Gewicht kompl.: 1,664 kg

Verp. Abmaße : L x B x H (1 Stck. in Folie)
300 x 250 x 87 mm
Gewicht kompl.: 1,670 kg