

Technisches Datenblatt / Technical Datasheet

Art.-No. 61805

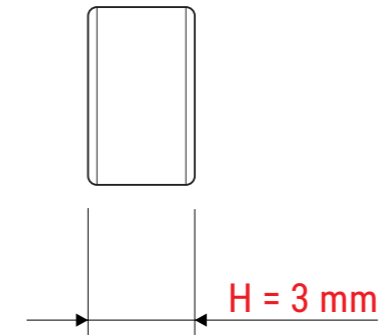
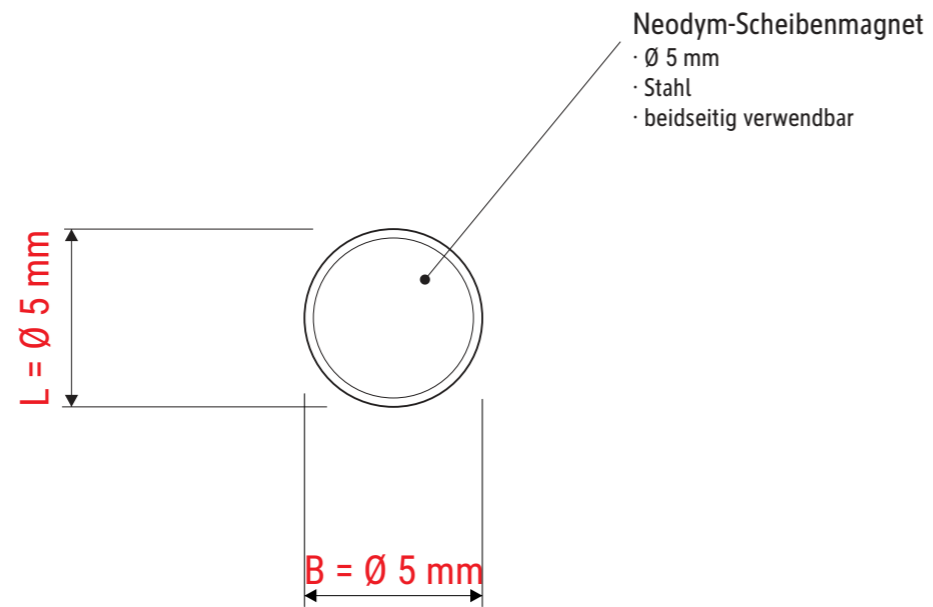

Haftkraft: 0,7 kg

Abmaße Produkt: **L x B x H**
5 x 5 x 3 mm
Gewicht: 0,0004 kg

Verp. Abmaße : L x B x H (10 Stck. im Karton)
95 x 89 x 27 mm
Gewicht kompl.: 0,033 kg