

# Technisches Datenblatt / Technical Datasheet

## Art.-No. 90250

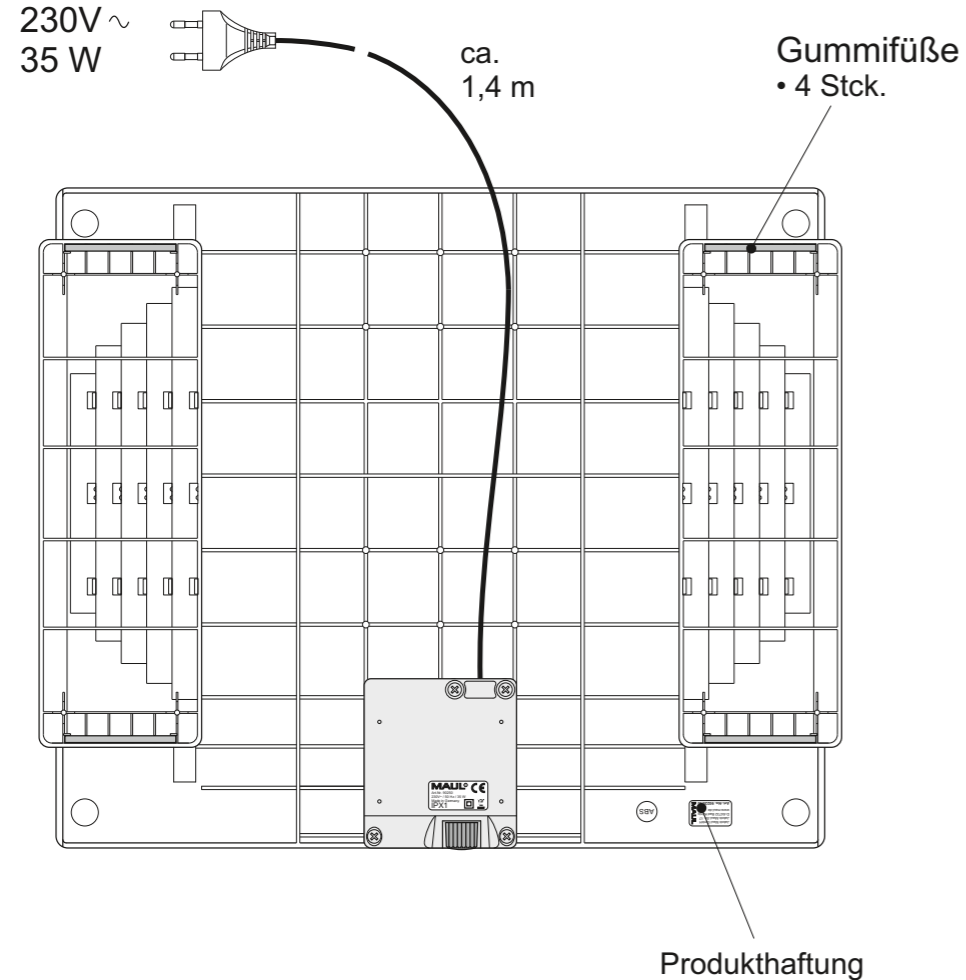

**Ansicht von unten**



**Ansicht von oben**

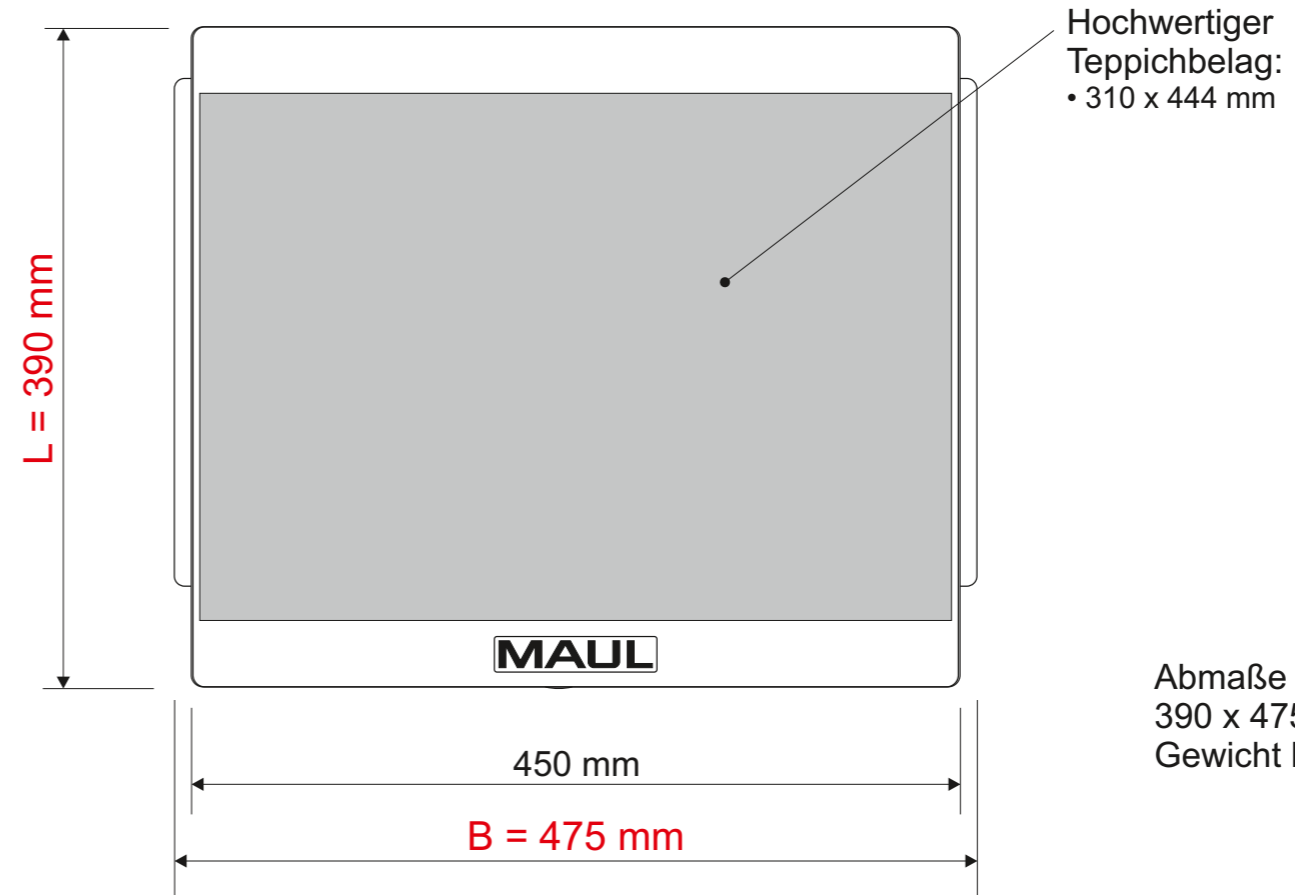

Abmaße Produkt: **L x B x H**  
390 x 475 x 117 mm  
Gewicht kompl.: 2,077 kg

**Ansicht von vorne**

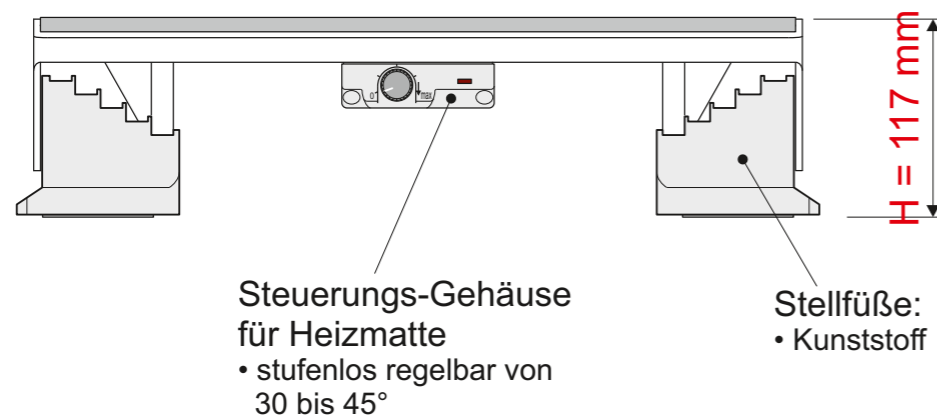

**Ansicht von der Seite**

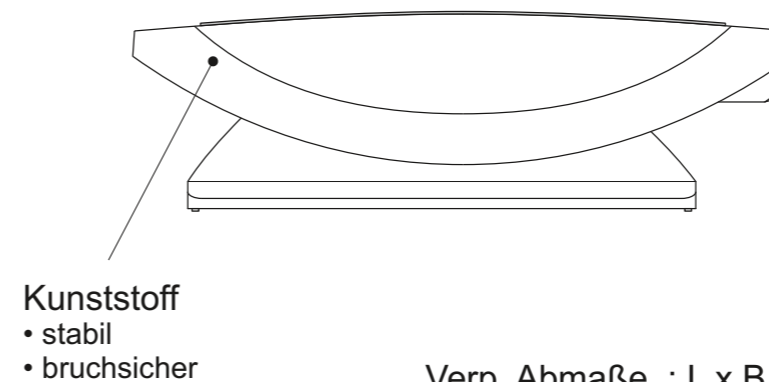

Verp. Abmaße : L x B x H  
480 x 405 x 122 mm  
Gewicht kompl.: 2,481 kg

- Grundstellung
- Stellfläche: 450 x 390 mm
- Belastung: max. 50 kg
- höhenverstellbar in 5 Stufen  
(siehe Seite 2)
- stufenlos neigbar

1. Stufe =  
Grund-  
stellung

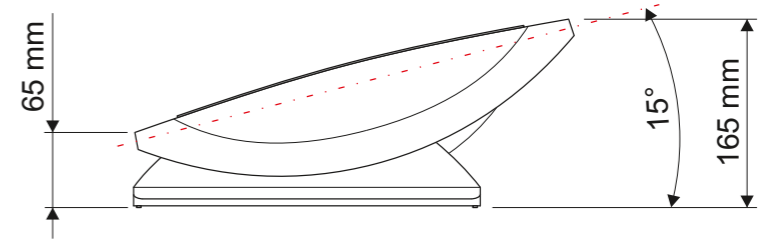
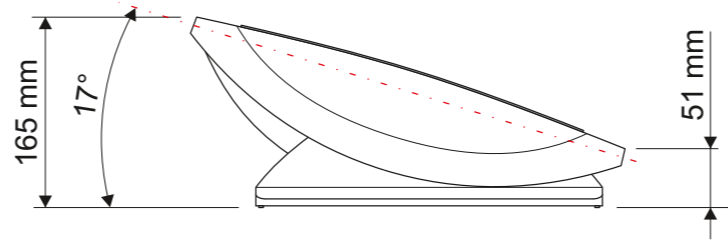

2. Stufe

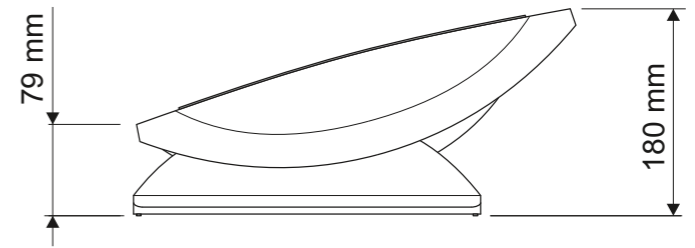
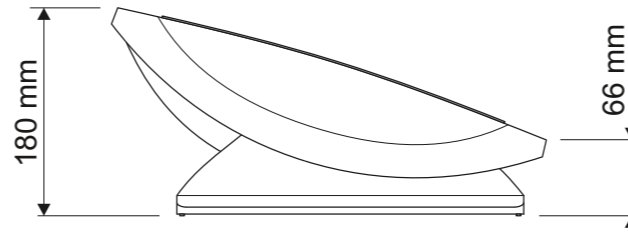
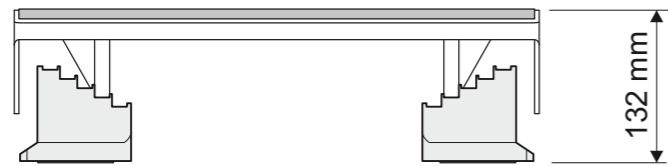

3. Stufe

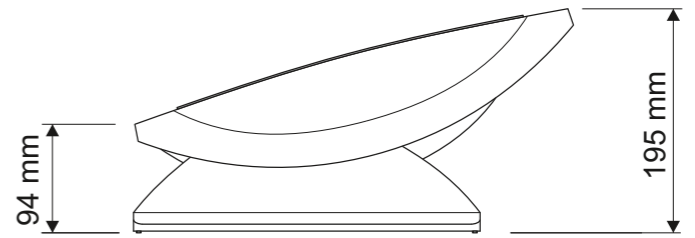
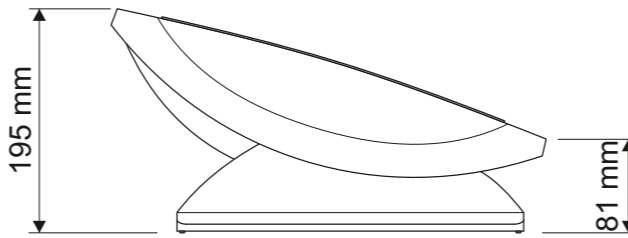
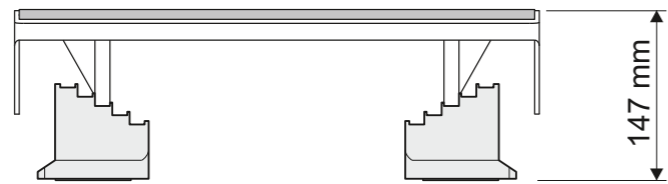

4. Stufe

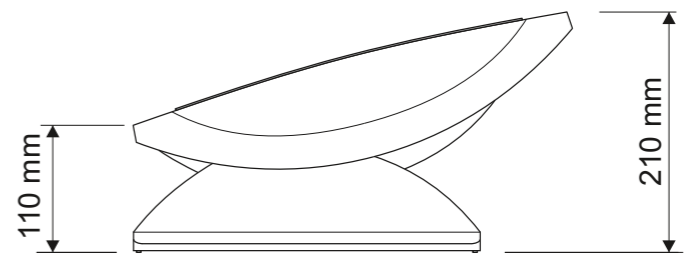
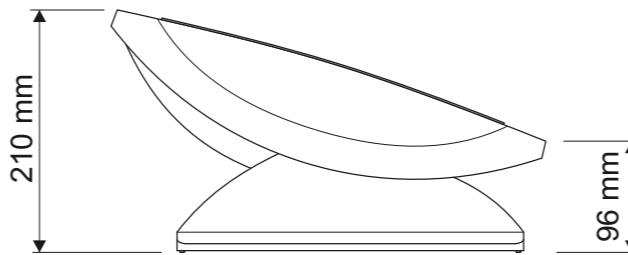
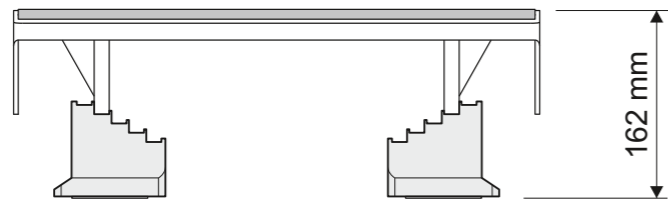

5. Stufe

