

Technisches Datenblatt / Technical Datasheet

Art.-No. 90250

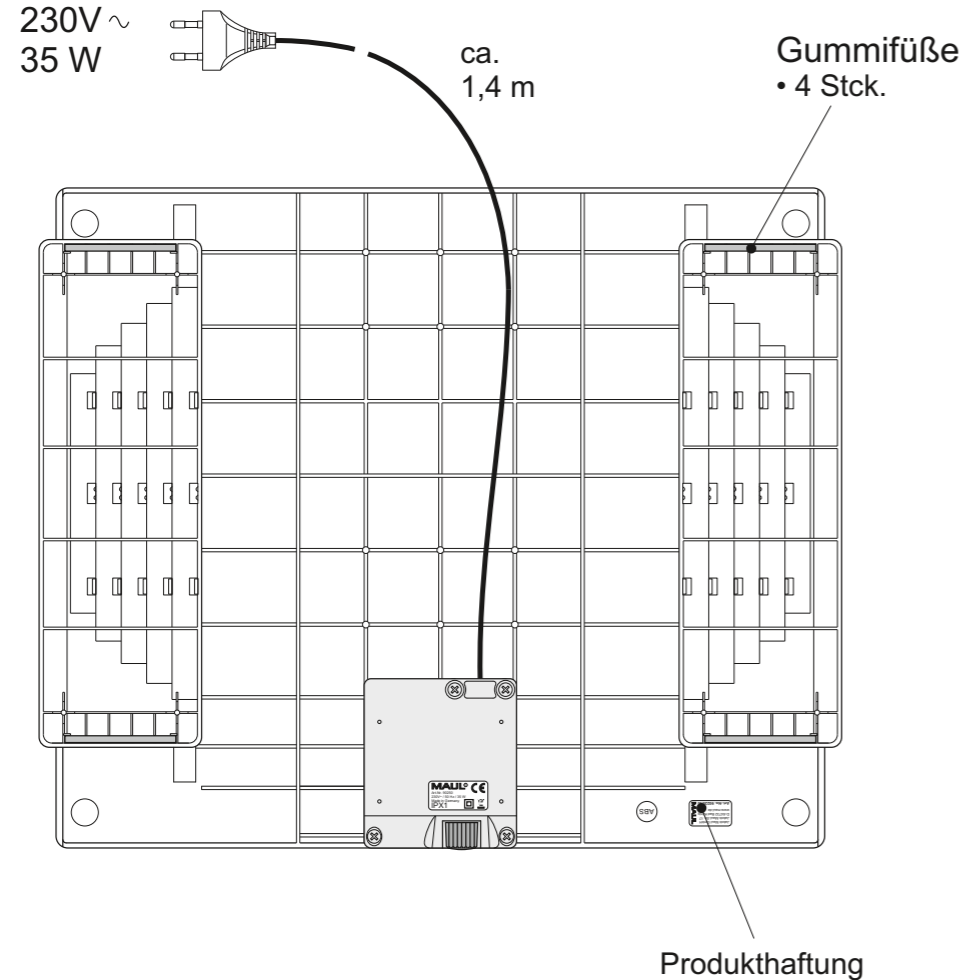

Ansicht von unten



Ansicht von oben

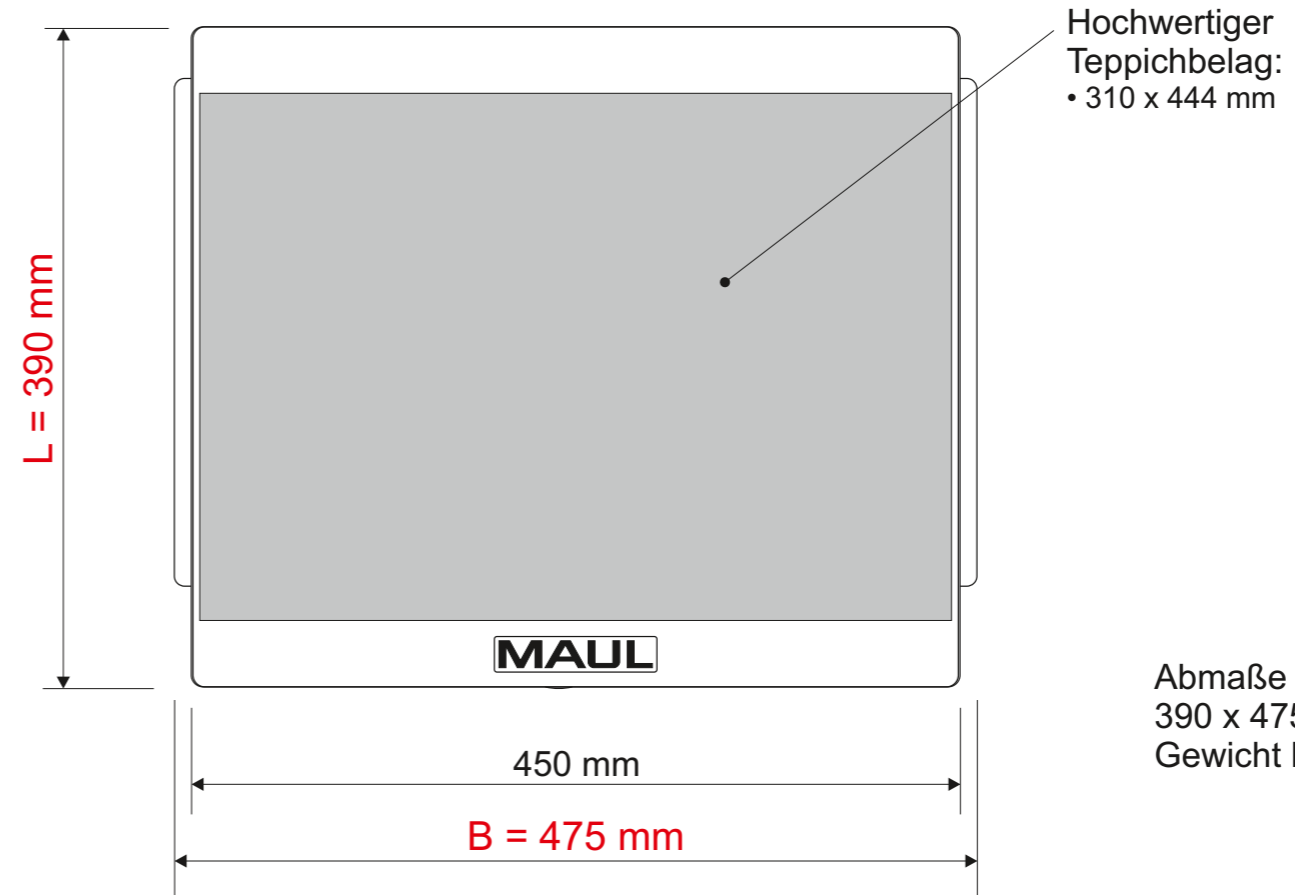

AbmaÙe Produkt: L x B x H
390 x 475 x 117 mm
Gewicht kompl.: 2,077 kg

Ansicht von vorne

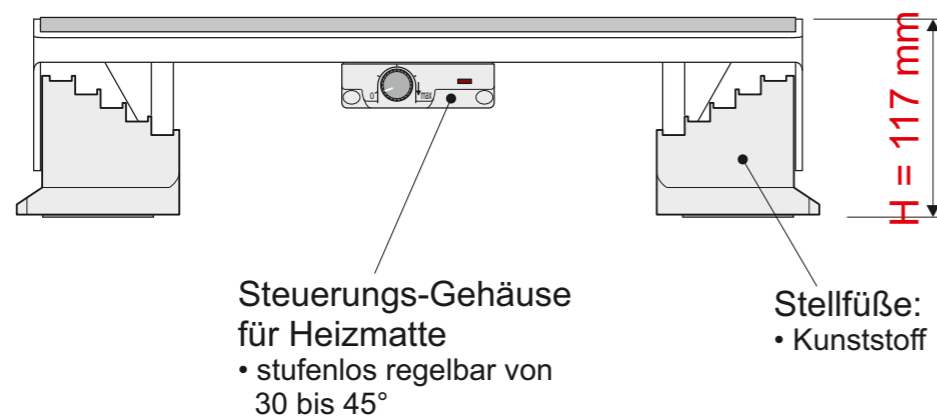

Ansicht von der Seite

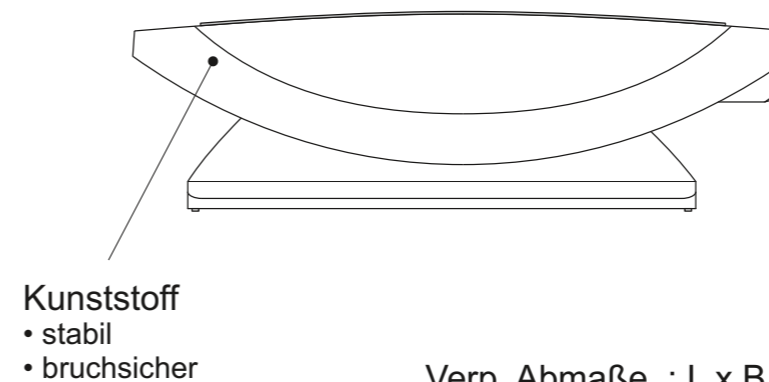

Verp. AbmaÙe : L x B x H
480 x 405 x 122 mm
Gewicht kompl.: 2,481 kg

- Grundstellung
- Stellfläche: 450 x 390 mm
- Belastung: max. 50 kg
- höhenverstellbar in 5 Stufen (siehe Seite 2)
- stufenlos neigbar

1. Stufe =
Grund-
stellung

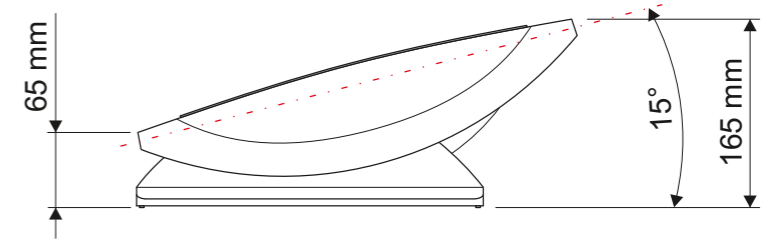
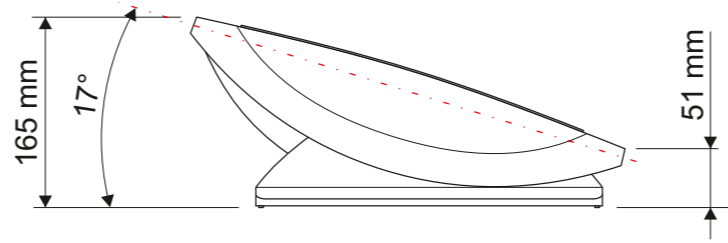

2. Stufe

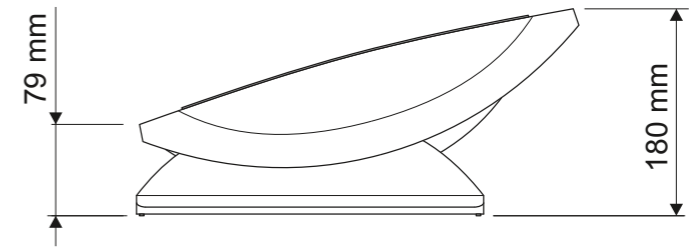
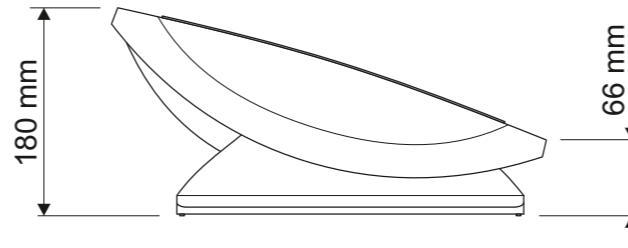
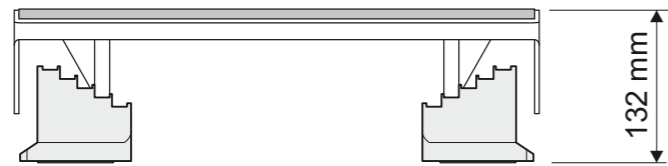

3. Stufe

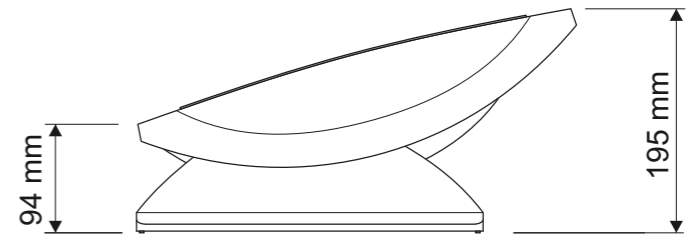
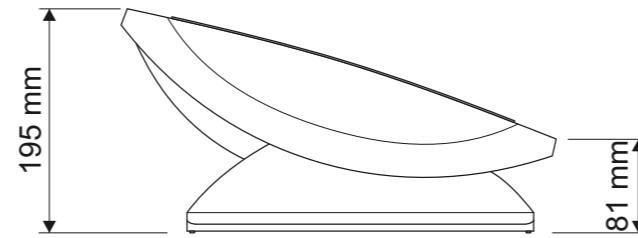
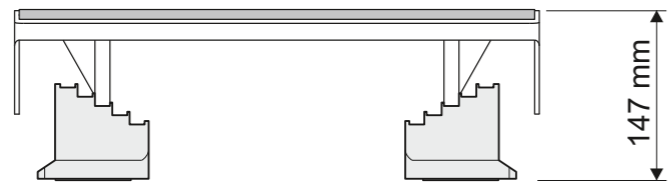

4. Stufe

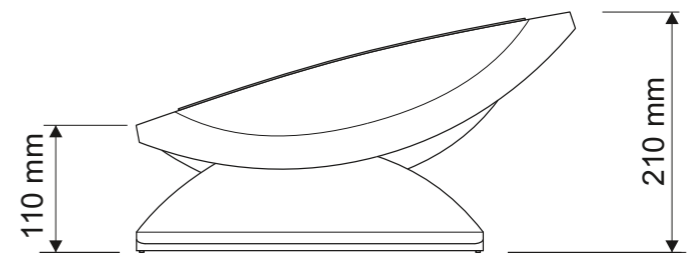
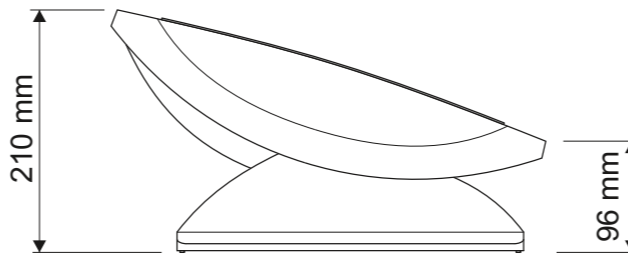
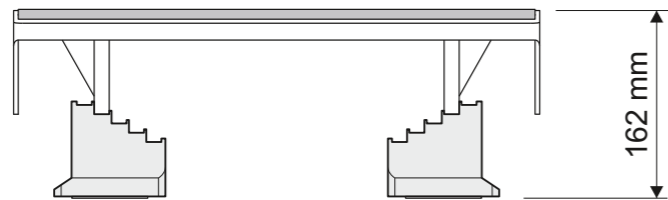

5. Stufe

