

Art.-No.: 8201509.200

1

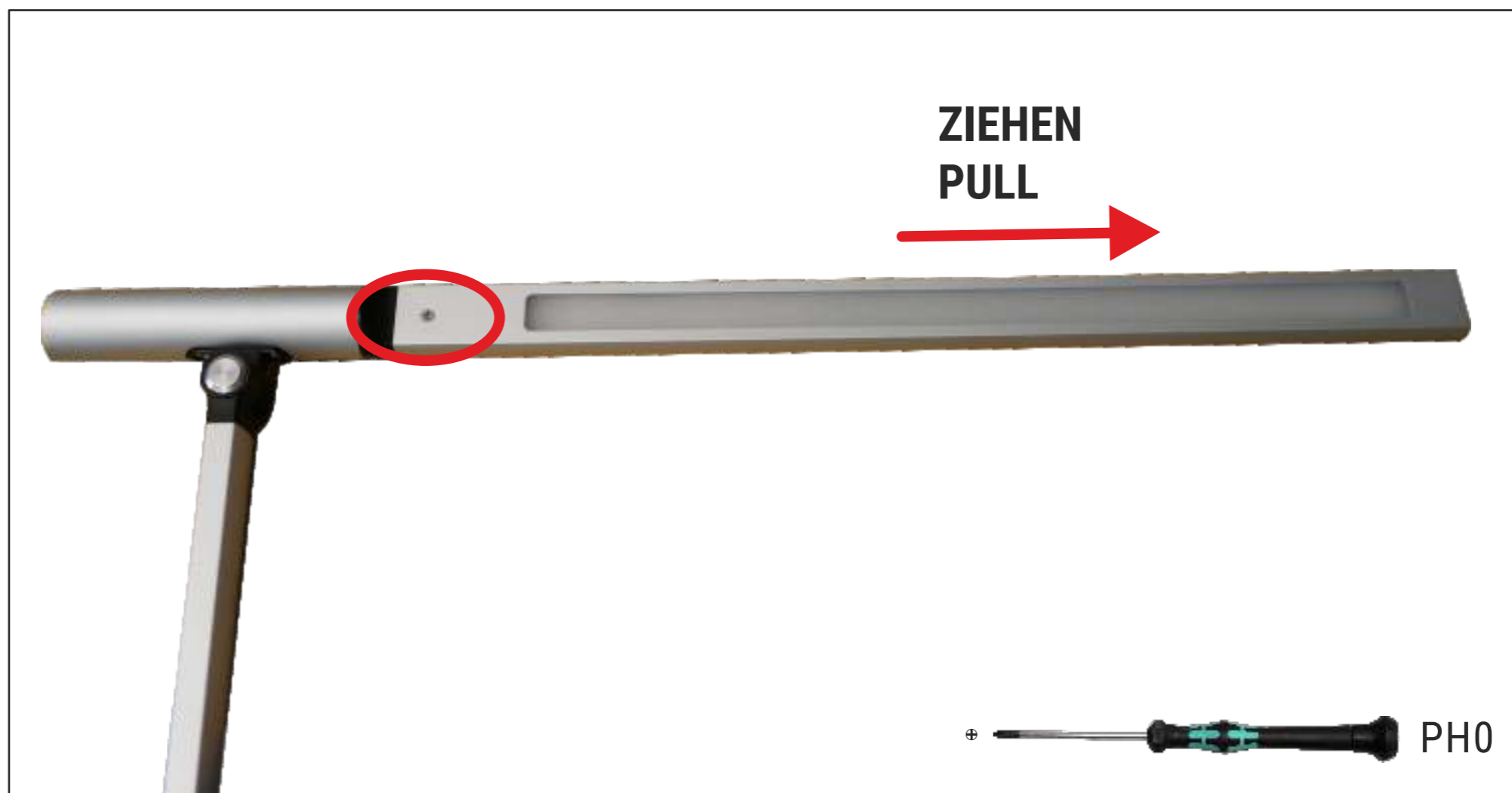

2

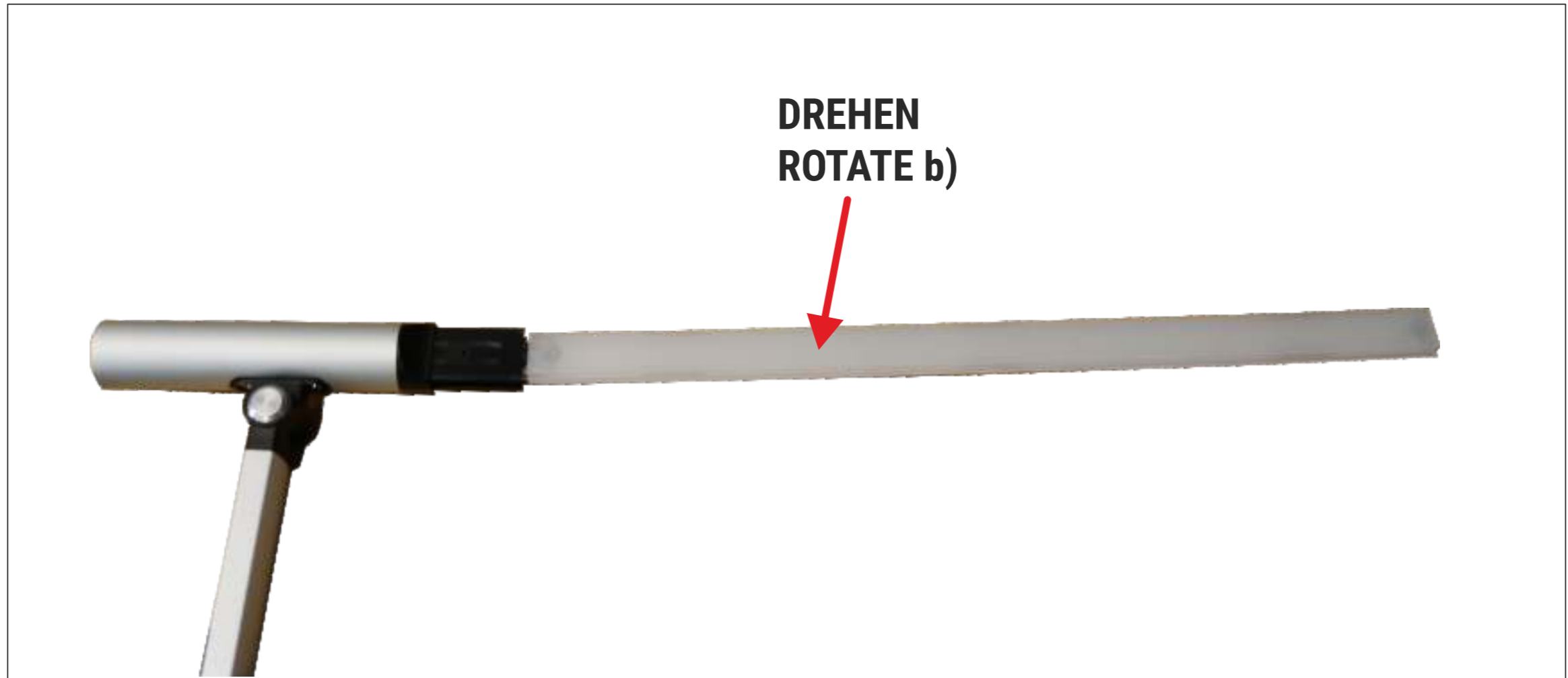

3

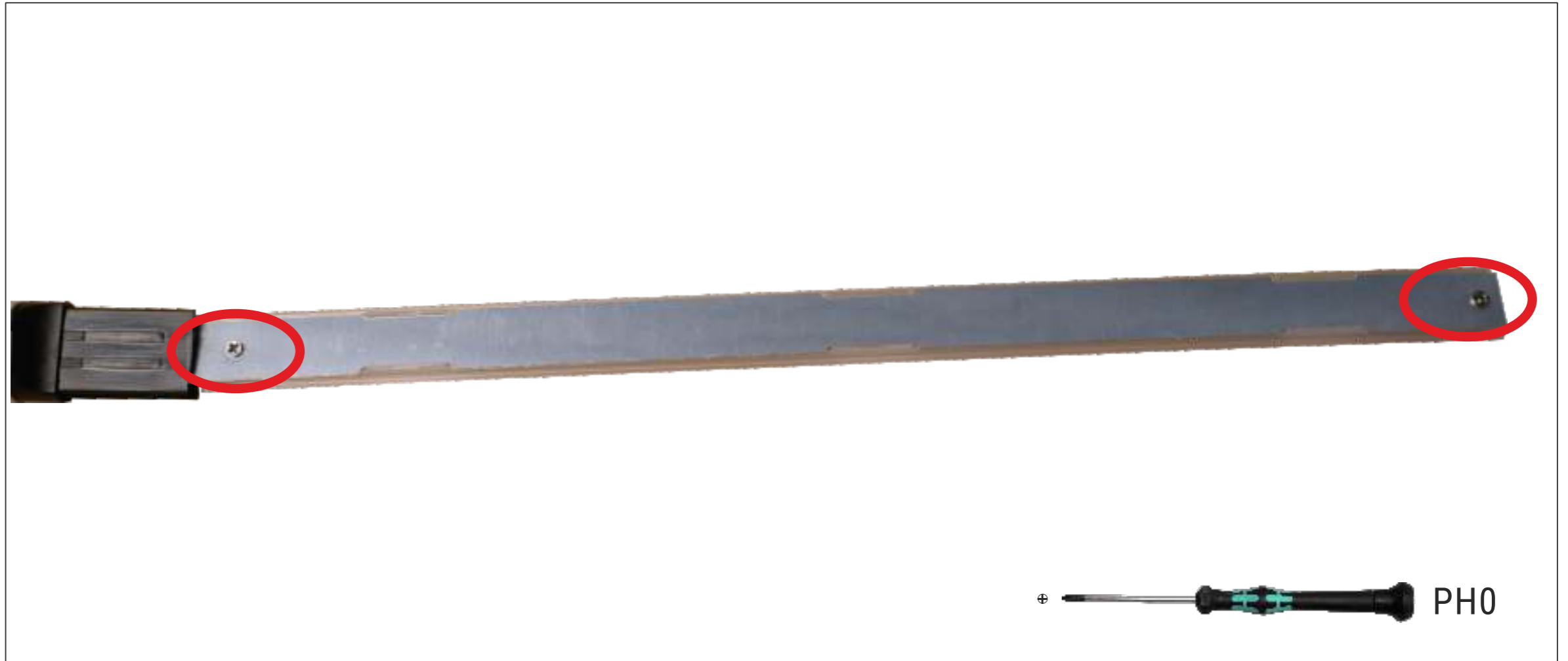

4

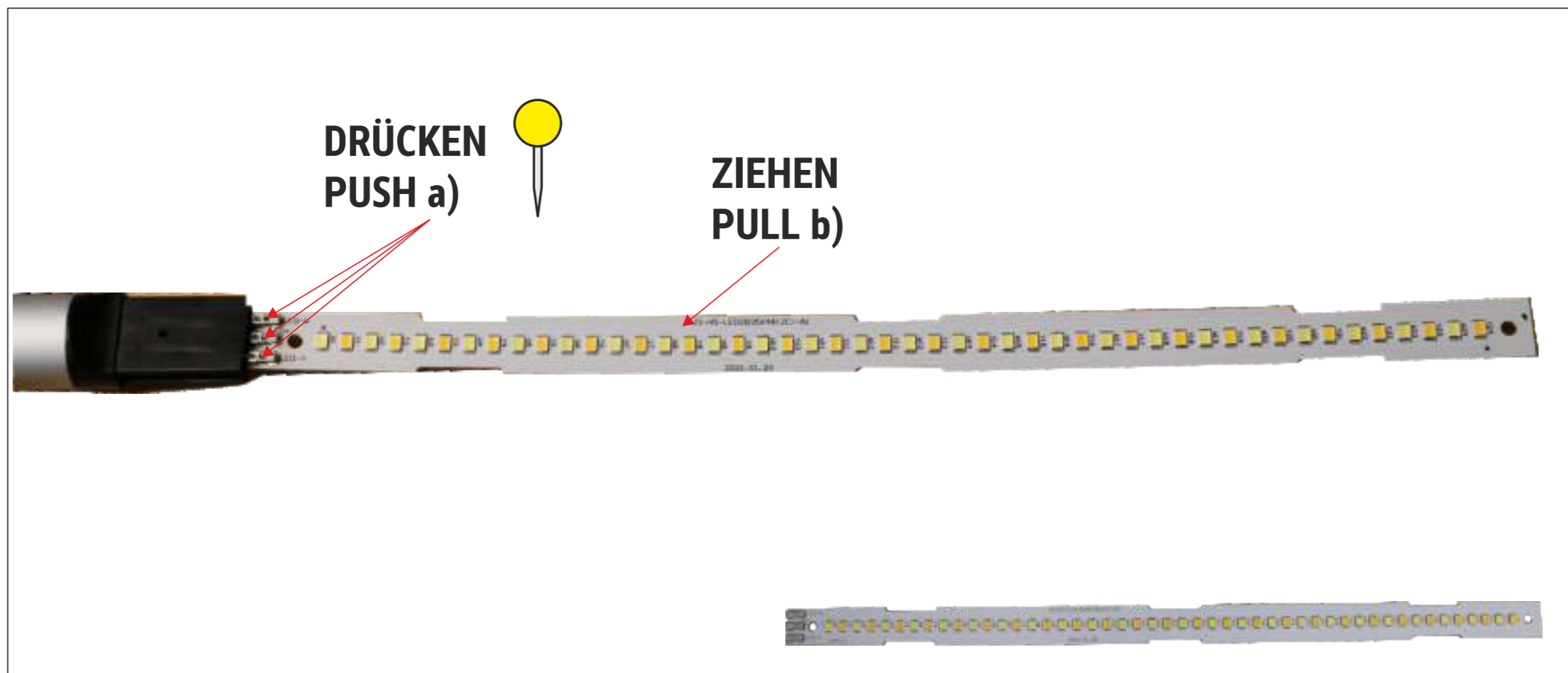

B

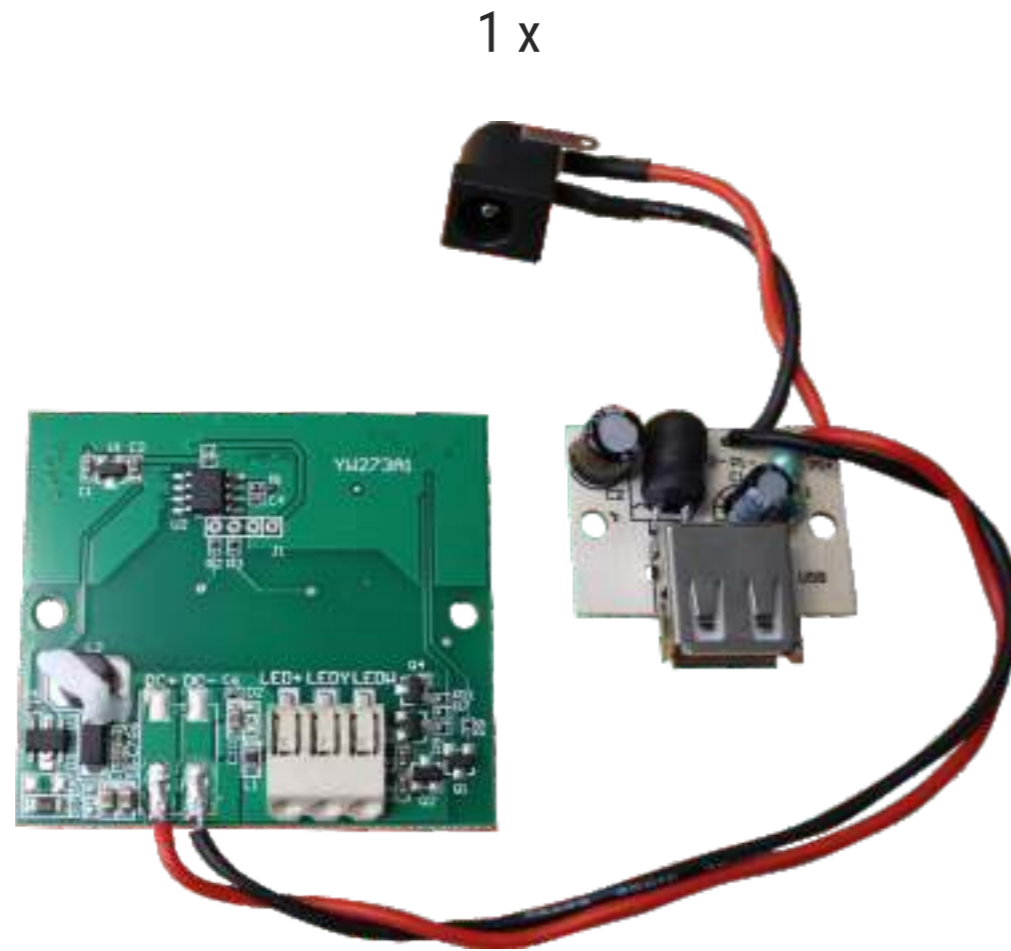

Art.-No.: 8201509.220

1



2



3

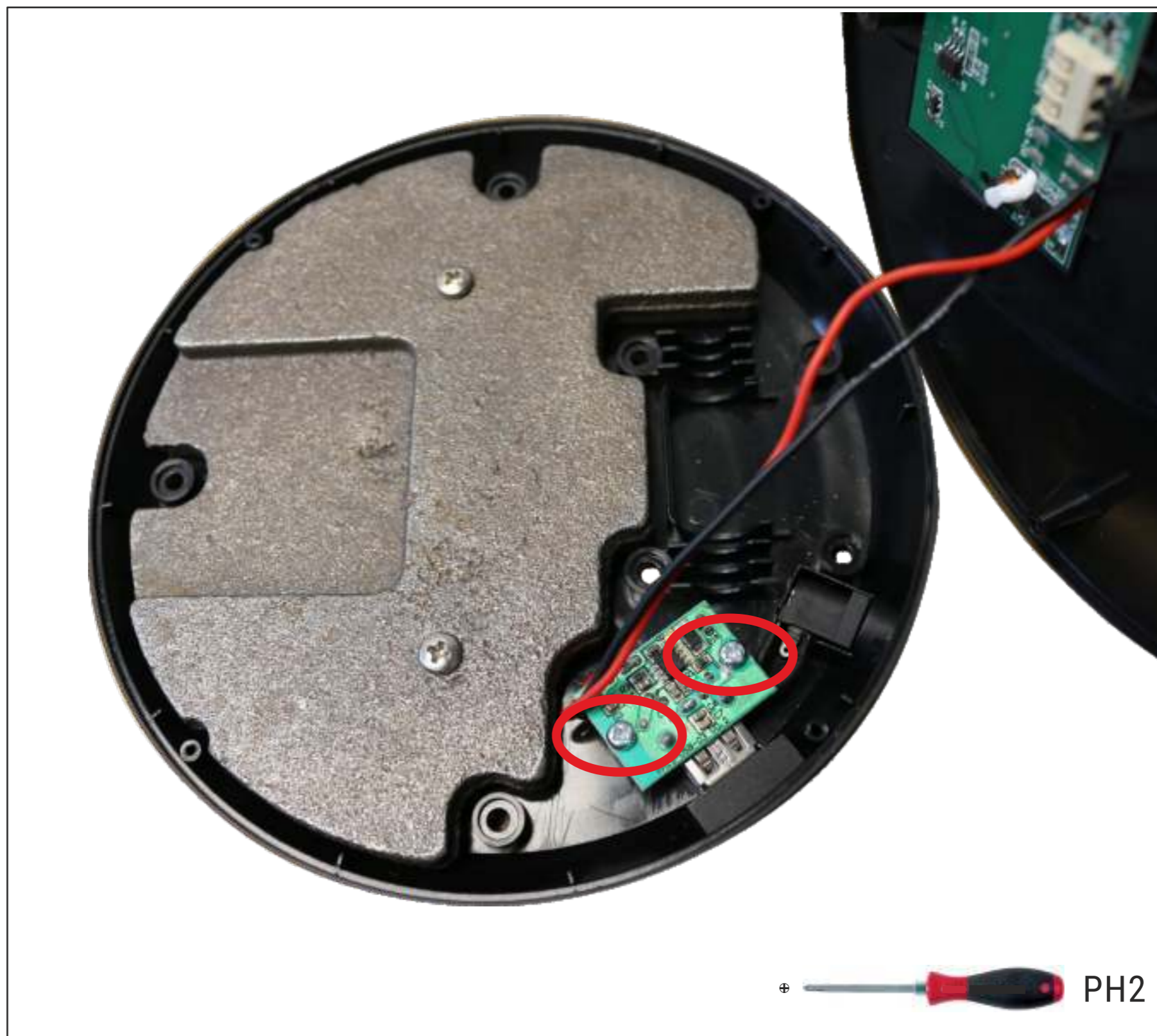

4

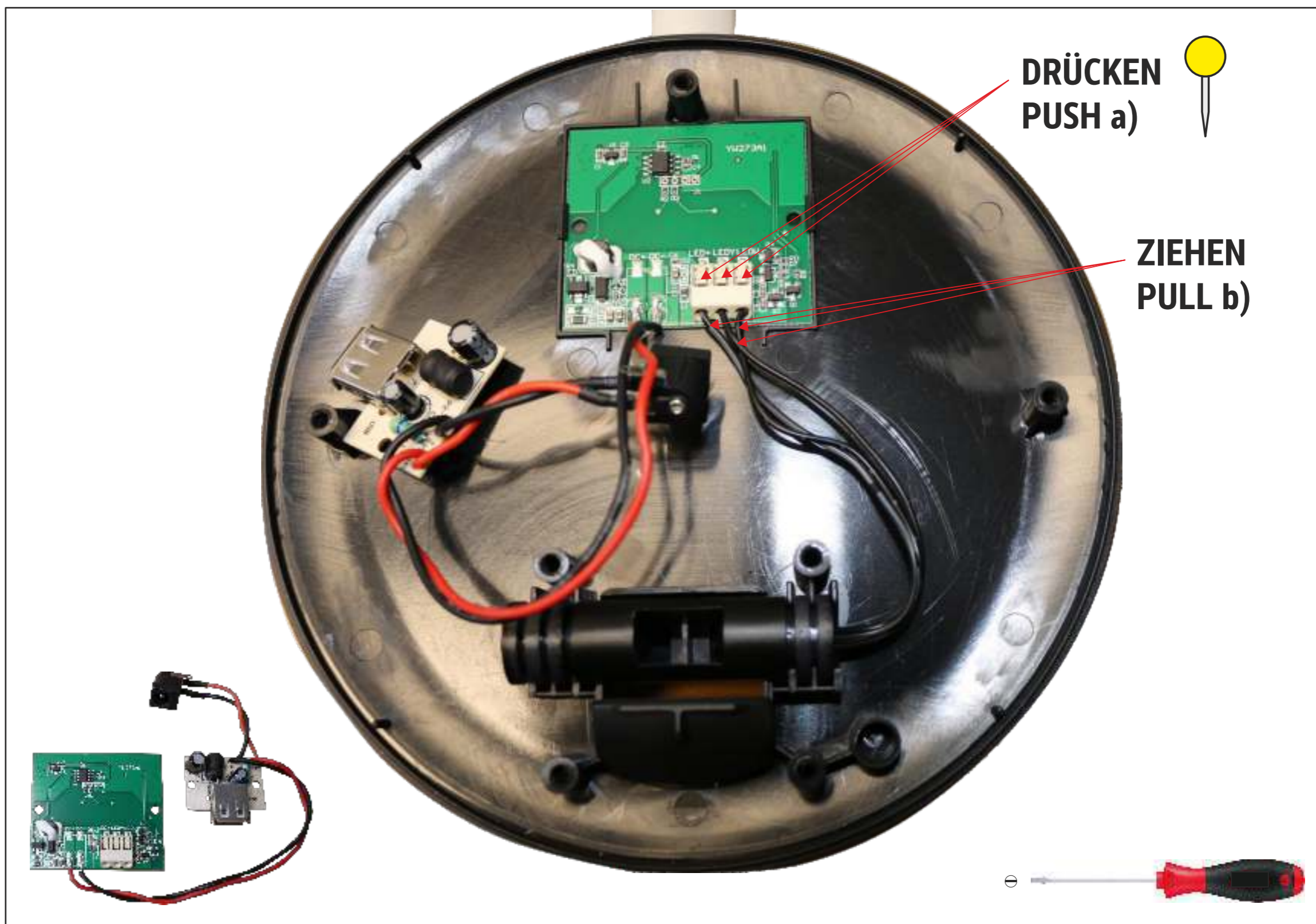

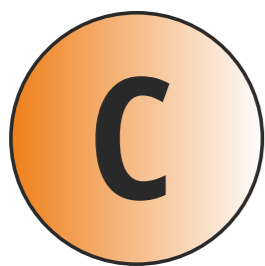

Art.-No.: 8201509.215

1

